

Digital HD Video Camera Recorder

HANDYCAM®

Operating Guide

HDR-UX10/UX20

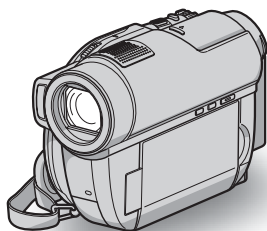

Enjoying with your
camcorder 13

Getting Started 21

Recording/Playback 34

Editing 56

Utilizing the media 72

Customizing your
camcorder 84

Performing with a
computer 105

Troubleshooting 109

Additional Information 124

Quick Reference 139

Spanish Quick Guide/
Guía rápida en español 149

AVCHD



InfoLITHIUM



HDMI

WARNING

To reduce fire or shock hazard, do not expose the unit to rain or moisture.

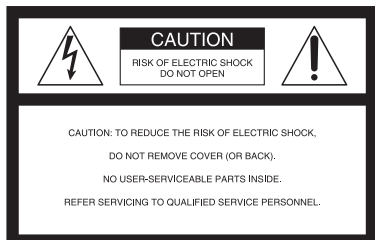

This symbol is intended to alert the user to the presence of uninsulated “dangerous voltage” within the product’s enclosure that may be of sufficient magnitude to constitute a risk of electric shock to persons.



This symbol is intended to alert the user to the presence of important operating and maintenance (servicing) instructions in the literature accompanying the appliance.

IMPORTANT SAFEGUARDS

For your protection, please read these safety instructions completely before operating the appliance, and keep this manual for future reference.

Carefully observe all warnings, precautions and instructions on the appliance, or the one described in the operating instructions and adhere to them.

Use

Power Sources

This set should be operated only from the type of power source indicated on the marking label. If you are not sure of the type of electrical power supplied to your home, consult your dealer or local power company. For those sets designed to operate from battery power, or other sources, refer to the operating instructions.

Polarization

This set may be equipped with a polarized ac power cord plug (a plug having one blade wider than the other).

This plug will fit into the power outlet only one way. This is a safety feature. If you are unable to insert the plug fully into the outlet, try reversing the plug. If the plug should still fail to fit, contact your electrician to have a suitable outlet installed. Do not defeat the safety purpose of the polarized plug by forcing it in.

Overloading

Do not overload wall outlets, extension cords or convenience receptacles beyond their capacity, since this can result in fire or electric shock.

Object and Liquid Entry

Never push objects of any kind into the set through openings as they may touch dangerous voltage points or short out parts that could result in a fire or electric shock. Never spill liquid of any kind on the set.

Attachments

Do not use attachments not recommended by the manufacturer, as they may cause hazards.

Cleaning

Unplug the set from the wall outlet before cleaning or polishing it. Do not use liquid cleaners or aerosol cleaners. Use a cloth lightly dampened with water for cleaning the exterior of the set.

Installation

Water and Moisture

Do not use power-line operated sets near water – for example, near a bathtub, washbowl, kitchen sink, or laundry tub, in a wet basement, or near a swimming pool, etc.

Power-Cord Protection

Route the power cord so that it is not likely to be walked on or pinched by items placed upon or against them, paying particular attention to the plugs, receptacles, and the point where the cord exits from the appliance.

Accessories

Do not place the set on an unstable cart, stand, tripod, bracket, or table. The set may fall, causing serious injury to a child or an adult, and serious damage to the set. Use only a cart, stand, tripod, bracket, or table recommended by the manufacturer.

Ventilation

The slots and openings in the cabinet are provided for necessary ventilation. To ensure reliable operation of the set, and to protect it from overheating, these slots and openings must never be blocked or covered.

- Never cover the slots and openings with a cloth or other materials.
- Never block the slots and openings by placing the set on a bed, sofa, rug, or other similar surface.
- Never place the set in a confined space, such as a bookcase, or built-in cabinet, unless proper ventilation is provided.
- Do not place the set near or over a radiator or heat register, or where it is exposed to direct sunlight.

IMPORTANT SAFEGUARDS (Continued)

Lightning

For added protection for this set during a lightning storm, or when it is left unattended and unused for long periods of time, unplug it from the wall outlet and disconnect the antenna or cable system. This will prevent damage to the set due to lightning and power-line surges.

Service

Damage Requiring Service

Unplug the set from the wall outlet and refer servicing to qualified service personnel under the following conditions:

- When the power cord or plug is damaged or frayed.
- If liquid has been spilled or objects have fallen into the set.
- If the set has been exposed to rain or water.
- If the set has been subject to excessive shock by being dropped, or the cabinet has been damaged.
- If the set does not operate normally when following the operating instructions. Adjust only those controls that are specified in the operating instructions. Improper adjustment of other controls may result in damage and will often require extensive work by a qualified technician to restore the set to normal operation.
- When the set exhibits a distinct change in performance – this indicates a need for service.

Servicing

Do not attempt to service the set yourself as opening or removing covers may expose you to dangerous voltage or other hazards.

Refer all servicing to qualified service personnel.

Replacement parts

When replacement parts are required, be sure the service technician has used replacement parts specified by the manufacturer that have the same characteristics as the original parts.

Unauthorized substitutions may result in fire, electric shock, or other hazards.

Safety Check

Upon completion of any service or repairs to the set, ask the service technician to perform routine safety checks (as specified by the manufacturer) to determine that the set is in safe operating condition.

Read this before operating your camcorder

Before operating the unit, please read this manual thoroughly, and retain it for future reference.

WARNING

Do not expose the batteries to excessive heat such as sunshine, fire or the like.

CAUTION

The use of optical instruments with this product will increase eye hazard. Use of controls or adjustments or performance of procedures other than those specified herein may result in hazardous radiation exposure.

Replace the battery with the specified type only. Otherwise, fire or injury may result.

Owner's Record

The model and serial numbers are located on the bottom. Record the serial number in the space provided below. Refer to these numbers whenever you call upon your Sony dealer regarding this product.

Model No. HDR- _____

Serial No. _____

Model No. AC- _____

No. _____

For customers in the U.S.A. and CANADA

RECYCLING LITHIUM-ION BATTERIES

Lithium-Ion batteries are recyclable. You can help preserve our environment by returning your used rechargeable batteries to the collection and recycling location nearest you.

For more information regarding recycling of rechargeable batteries, call toll free 1-800-822-8837, or visit <http://www.rbrc.org/>



Caution: Do not handle damaged or leaking Lithium-Ion batteries.

For customers in the U.S.A.

If you have any questions about this product, you may call:

Sony Customer Information Center
1-800-222-SONY (7669).

The number below is for the FCC related matters only.

Regulatory Information

Declaration of Conformity

Trade Name: SONY

Model No.: HDR-UX10

Responsible Party: Sony Electronics Inc.

Address: 16530 Via Esprillo, San Diego, CA 92127 U.S.A.

Telephone No.: 858-942-2230

This device complies with Part 15 of the FCC Rules. Operation is subject to the following two conditions: (1) This device may not cause harmful interference, and (2) this device must accept any interference received, including interference that may cause undesired operation.

Declaration of Conformity

Trade Name: SONY

Model No.: HDR-UX20

Responsible Party: Sony Electronics Inc.

Address: 16530 Via Esprillo, San Diego, CA 92127 U.S.A.

Telephone No.: 858-942-2230

This device complies with Part 15 of the FCC Rules. Operation is subject to the following two conditions: (1) This device may not cause harmful interference, and (2) this device must accept any interference received, including interference that may cause undesired operation.

CAUTION

You are cautioned that any changes or modifications not expressly approved in this manual could void your authority to operate this equipment.

Read this before operating your camcorder (Continued)

Note

This equipment has been tested and found to comply with the limits for a Class B digital device, pursuant to Part 15 of the FCC Rules.

These limits are designed to provide reasonable protection against harmful interference in a residential installation. This equipment generates, uses, and can radiate radio frequency energy and, if not installed and used in accordance with the instructions, may cause harmful interference to radio communications.

However, there is no guarantee that interference will not occur in a particular installation. If this equipment does cause harmful interference to radio or television reception, which can be determined by turning the equipment off and on, the user is encouraged to try to correct the interference by one or more of the following measures:

- Reorient or relocate the receiving antenna.
- Increase the separation between the equipment and receiver.
- Connect the equipment into an outlet on a circuit different from that to which the receiver is connected.
- Consult the dealer or an experienced radio/TV technician for help.

The supplied interface cable must be used with the equipment in order to comply with the limits for a digital device pursuant to Subpart B of Part 15 of FCC Rules.

For the State of California, USA only

Perchlorate Material - special handling may apply. See www.dtsc.ca.gov/hazardouswaste/perchlorate
Perchlorate Material: Lithium battery contains perchlorate.

Notes on use

Your camcorder is supplied with two kinds of operations guides.

- “Operating Guide” (This manual)
- “PMB Guide” for using your camcorder with a computer connected (stored on the supplied CD-ROM) (p. 105).

Types of the disc you can use in your camcorder

You can use the following discs only.

- 8 cm DVD-RW
- 8 cm DVD+RW
- 8 cm DVD-R
- 8 cm DVD+R DL

Use the discs with marks listed below. See page 16 for details.



For reliability and durability of recording/playback, we recommend that you use Sony discs or discs with an  for VIDEO CAMERA TM *(for VIDEO CAMERA) mark for your camcorder.

* Depending on the place you bought, the disc has a  for VIDEO CAMERA TM or iF TM mark.

Notes

- Using a disc other than above may cause the unsatisfactory recording/playback or you may not be able to remove the disc from your camcorder.

Types of “Memory Stick” you can use in your camcorder

- For recording movies, it is recommended that you use a “Memory Stick PRO Duo” of 1 GB or larger marked with:
 - MEMORY STICK PRO DUO (“Memory Stick PRO Duo”)
 - MEMORY STICK PRO-HG DUO (“Memory Stick PRO-HG Duo”)

* You can use “Memory Stick PRO Duo” whether Mark2 is indicated or not.

- See page 33 for the recordable time of a “Memory Stick PRO Duo.”

“Memory Stick PRO Duo” / “Memory Stick PRO-HG Duo”

(This size can be used with your camcorder.)



“Memory Stick”

(You cannot use it in your camcorder.)



- “Memory Stick PRO Duo” and “Memory Stick PRO-HG Duo” are both referred to as “Memory Stick PRO Duo” in this manual.
- You cannot use any type of memory card other than those mentioned above.
- “Memory Stick PRO Duo” can be used only with “Memory Stick PRO” compatible equipment.
- Do not attach a label or the like on a “Memory Stick PRO Duo” or a Memory Stick Duo Adaptor.
- When using a “Memory Stick PRO Duo” with “Memory Stick” compatible equipment, insert the “Memory Stick PRO Duo” into the Memory Stick Duo Adaptor.

Using the camcorder

- Do not hold the camcorder by the following parts.





Viewfinder

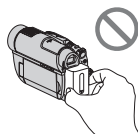

LCD screen



Battery

- The camcorder is not dustproof, dripproofed or waterproofed. See “About handling of your camcorder” (p. 131).
- To prevent the media from being broken or recorded images from being lost, do not do the following when either of the  (Movie)/ (Still) lamps (p. 25) or the ACCESS lamp (p. 30) /access lamp (p. 32) is lit or flashing:
 - to remove the battery pack or AC Adaptor from the camcorder.
 - to apply mechanical shock or vibration to the camcorder.
 - to eject the “Memory Stick PRO Duo.”
- When connecting your camcorder to another device with a cable, be sure to insert the connector plug in the correct way. Pushing the plug forcibly into the terminal will damage the terminal and may result in a malfunction of your camcorder.

About menu items, LCD panel, viewfinder, and lens

- A menu item that is grayed out is not available under the current recording or playback conditions.
- The LCD screen and the viewfinder are manufactured using extremely high-precision technology, so over 99.99% of the pixels are operational for effective use. However, there may be some tiny black points and/or bright points (white, red, blue, or green in color) that appear constantly on the LCD screen and the viewfinder. These points are normal results of the manufacturing process and do not affect the recording in any way.

Read this before operating your camcorder (Continued)

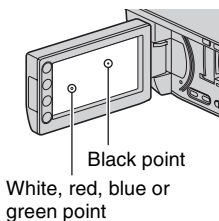

- Exposing the LCD screen, the viewfinder, or the lens to direct sunlight for long periods of time may cause malfunctions.
- Do not aim at the sun. Doing so might cause your camcorder to malfunction. Take images of the sun only in low light conditions, such as at dusk.

On recording

- Before starting to record, test the recording function to make sure the image and sound are recorded without any problems.
HDR-UX10:
It is recommended that you use a DVD-RW/DVD+RW for trial recording (p. 38).
HDR-UX20:
It is recommended that you use the internal memory of your camcorder for trial recording (p. 38).
- Compensation for the contents of recordings cannot be provided, even if recording or playback is not possible due to a malfunction of the camcorder, storage media, etc.
- TV color systems differ depending on the countries/regions. To view your recordings on a TV, you need a NTSC system-based TV.
- Television programs, films, video tapes, and other materials may be copyrighted. Unauthorized recording of such materials may be contrary to the copyright laws.

If you cannot record/play back images, format the media

If you repeat recording/deleting images for a long time, fragmentation of data occurs on the internal memory (HDR-UX20) or a “Memory Stick PRO Duo.” Images cannot be saved or recorded. In such a case, save the images on other media (p. 61, 68, 105) first, then format the media (p. 78).

About changing the language setting

The on-screen displays in each local language are used for illustrating the operating procedures. Change the screen language before using your camcorder if necessary (p. 26).

On playing back recorded images on other devices

- Your camcorder is compatible with MPEG-4 AVC/H.264 High Profile for HD (high definition) image quality recording. Therefore, you cannot play back images recorded with HD (high definition) image quality on your camcorder with the following devices;
 - Other AVCHD-compatible devices which are not compatible with High Profile
 - Devices which are not compatible with the AVCHD format

Note on disposal/transfer (HDR-UX20)

Even if you format the internal memory (p. 78), you may not delete data from the internal memory completely. When you transfer the camcorder, it is recommended that you perform [ EMPTY] (p. 83) to prevent the recovery of your data. In addition to the above, when you dispose of the camcorder, it is recommended that you destroy the actual body of the camcorder.

About the Carl Zeiss lens

Your camcorder is equipped with a Carl Zeiss lens, which was developed jointly by Carl Zeiss, in Germany, and Sony Corporation, and produces superior images. It adopts the MTF measurement system for video cameras and offers a quality typical of a Carl Zeiss lens. Also, the lens for your camcorder is T*~~*~~-coated to suppress unwanted reflections and faithfully reproduce colors.

MTF= Modulation Transfer Function. The number value indicates the amount of light from a subject coming into the lens.

About this manual

- The images of the LCD screen and the viewfinder used in this manual for illustration purposes are captured using a digital still camera, and therefore may appear different.
- 8 cm DVD disc is referred to as “Disc” in this manual.
- The internal memory, disc and “Memory Stick PRO Duo” are all referred to as “Media” in this manual.
- Design and specifications of recording media and other accessories are subject to change without notice.
- The illustrations used on this manual are based on the model HDR-UX20.

About the marks used in this manual

The operations available depend on the media used. The following marks are used to indicate the type of media you can use for a particular operation.

Internal memory



Disc



“Memory Stick PRO Duo”



Table of Contents

IMPORTANT SAFEGUARDS	3
Read this before operating your camcorder	5
Subject examples and solutions ...	12

Enjoying with your camcorder

Enjoy using various “Media” according to your needs	13
Operation flow	14
Features of the media	16
“HOME” and “OPTION” - Taking advantage of two types of menus	18

Getting Started

Step 1: Checking supplied items	21
Step 2: Charging the battery pack	22
Step 3: Turning the power on and setting the date and time	25
Changing the language setting	26
Step 4: Making adjustments before recording	27
Step 5: Selecting the media	28
Step 6: Inserting a disc or a “Memory Stick PRO Duo”	30

Recording/Playback

Recording and playback with ease (Easy Handycam operation)	34
Recording	38
Zooming	40
Recording sound with more presence (5.1ch surround recording)	40
Starting recording quickly (QUICK ON)	41

Recording high quality still images during movie recording (Dual Rec)	41
Recording in dark places (NightShot)	41
Adjusting the exposure for backlit subjects	42
Recording in mirror mode	42
Recording the fast action in slow-motion (SMTH SLW REC)	42
Playback	44
Searching for desired scenes by pinpoint (Film Roll Index)	47
Searching for desired scenes by face (Face Index)	47
Searching for desired images by date (Date Index)	48
Using PB zoom	48
Play back a series of still images (Slide show)	49
Playing the image on a TV	49

Editing





☰ (OTHERS) category	56
Deleting images	57
Capturing a still image from a movie	59
Dubbing/copying images from one media to another media on your camcorder	61
Dividing movies	64
Creating the Playlist	65
Dubbing movies to other recording devices	68
Printing recorded still images (PictBridge compliant printer)	70

Utilizing the media

🗑️ (MANAGE MEDIA) category	72
Making the disc compatible with playback on other devices (Finalizing)	73

Playing a disc on other devices	76
Checking the media information ...	78
Formatting the media	78
Recording additional movies after finalizing	80
Finding the right disc (DISC SELECT GUIDE)	81
Repairing the image database file	82
Preventing data on the internal memory of the camcorder from being recovered (HDR-UX20)	83

Customizing your camcorder

What you can do with the  (SETTINGS) category of the  HOME MENU	84
Using the HOME MENU	84
List of the  (SETTINGS) category items	84
MOVIE SETTINGS	86
(Items for recording movies)	
PHOTO SETTINGS	90
(Items for recording still images)	
VIEW IMAGES SET	92
(Items to customize the display)	
SOUND/DISP SET	93
(Items to adjust the sound and the screen)	
OUTPUT SETTINGS	95
(Items for connecting other devices)	
CLOCK/  LANG	96
(Items to set clock and language)	
GENERAL SET	96
(Other setup items)	
Activating functions using the 	
OPTION MENU	98
Using the OPTION MENU	98
Recording items on the OPTION MENU	98
Viewing items on the OPTION MENU	99

Functions set in the  OPTION MENU	100
--	-----

Performing with a computer

What you can do with Windows computer	105
--	-----

Troubleshooting

Troubleshooting	109
Warning indicators and messages	120

Additional Information

Using your camcorder abroad	124
Files/folder structure on the internal memory (HDR-UX20) and a "Memory Stick PRO Duo"	126
Precautions and maintenance	127
About the Disc	127
About the AVCHD format	128
About the "Memory Stick"	129
About the "InfoLITHIUM" battery pack	130
About the x.v.Color	131
About handling of your camcorder	131
Specifications	135

Quick Reference

Identifying parts and controls	139
Indicators displayed during recording/ playback	143
Glossary	145
Index	146

Spanish Quick Guide/Guía rápida en español 149

Subject examples and solutions

Checking your golf swing



- ▶ SMTH SLW REC 42

Getting a good shot of a ski slope or beach



- ▶ Back light..... 42
- ▶ BEACH 102
- ▶ SNOW 102

Capturing still images during movie recording

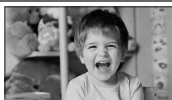

- ▶ Dual Rec 41

A child on the stage under a spot light



- ▶ SPOTLIGHT 102

Flowers in close-up



- ▶ PORTRAIT 102
- ▶ FOCUS 100
- ▶ TELE MACRO 100

Fireworks with all its splendor



- ▶ FIREWORKS 101
- ▶ FOCUS 100

Focusing on the dog on the left side of the screen



- ▶ FOCUS 100
- ▶ SPOT FOCUS 100

A sleeping child under dim light



- ▶ NightShot 41
- ▶ COLOR SLOW SHTR..... 103

Enjoy using various “Media” according to your needs

Selecting the media

You can select a desired media for recording/playback/editing from the internal memory (HDR-UX20), a disc or a “Memory Stick PRO Duo” (p. 28). To set the media for movies or still images, you can select either [MOVIE MEDIA SET] or [PHOTO MEDIA SET] according to your needs.

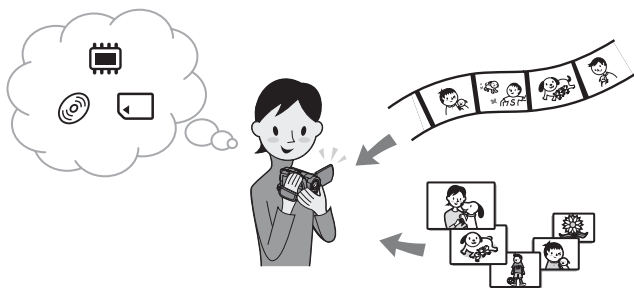

Dubbing from one media to another media

Using the [MOVIE DUB] function on your camcorder, you can dub movies recorded on the internal memory (HDR-UX20) or a “Memory Stick PRO Duo” to a disc without using other devices (p. 61).

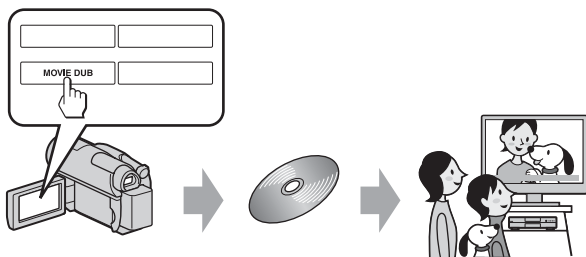

Operation flow

▶ Get ready

■ Selecting the media (p. 28)

Select the media of movies/still images according to your needs. For movies, set the desired image quality (HD (high definition) or SD (standard definition)) at the same time.



▶ Record using your camcorder (p. 38)

Your camcorder is compatible with the AVCHD format “1920 × 1080/60i” (p. 128), which provides highly detailed, beautiful images.



⚡ Notes

- The default setting is [HD SP] which is the AVCHD format “1440 × 1080/60i.” For details on how to change the setting, see page 86.
- You can also record movies with SD (standard definition) image quality.
- “AVCHD 1080i format” is abbreviated as “AVCHD” in this manual, except when it must be described in more detail.



► View movies recorded with HD (high definition) image quality

■ Viewing on a high definition TV

You can enjoy movies recorded with HD (high definition) image quality (p. 49).



💡 Tips

- Refer also to the information about [TV CONNECT Guide] (p. 50).
- You can also view movies on a non-high-definition (SD (standard definition)) TV.

■ Playing on AVCHD format compatible devices

If your device is AVCHD-compatible, you can play a disc or a “Memory Stick PRO Duo” with HD (high definition) image quality on the device.

Important notices

- Some AVCHD-format compatible devices may not be able to play back discs or “Memory Stick PRO Duo.”
- DVD based players/recorders are not AVCHD-format compatible, and discs with HD (high definition) image quality cannot be played back.
- Do not insert a disc with HD (high definition) image quality into a DVD based player/recorder. The disc may not be ejected from the DVD based player/recorder.



► Save recorded images

■ Dubbing/copying images from one media to another media on your camcorder (p. 61)

■ Dubbing movies to other recording devices (p. 68)

■ Editing images on a computer (p. 105)

Using the supplied application software “Picture Motion Browser,” you can import images to a computer, and save images on a disc.





Features of the media





You can save images on the internal memory (HDR-UX20) or DVD-RW, DVD+RW, DVD-R, and DVD+R DL discs of 8 cm in diameter on the camcorder. Also, you can save images on a “Memory Stick PRO Duo.” For details on the compatibility of the “Memory Stick” types, see page 6.

Disc types and features

What you can do with the recorded images depends on the image recording quality, HD (high definition) or SD (standard definition), and the type of disc you selected.

() indicates the reference page.

HD (high definition) image quality				
Disc type	DVD-RW	DVD+RW	DVD-R	DVD+R DL
Disc symbols				
Deleting or editing images on your camcorder (57, 64)	○	○	–	–
Finalizing required to play on other devices (73)	○	○	○	○
Making additional recordings on a finalized disc (80)	○	○	–	–
Formatting the used disc to use it again (79)	○	○	–	–
Making longer recordings on a side of a disc	–	–	–	○

SD (standard definition) image quality					
Disc type	DVD-RW [*]		DVD+RW	DVD-R	DVD+R DL
	VIDEO	VR			
Disc symbols					
Deleting the most recent movie (58)	○	○	○	–	–
Deleting or editing images on your camcorder (57, 64)	–	○	–	–	–
Finalizing required to play on other devices (73)	○	○	–**	○	○
Making additional recordings on a finalized disc (80)	○	○	○	–	–
Formatting the used disc to use it again (79)	○	○	○	–	–
Making longer recordings on a side of a disc	–	–	–	–	○

* There are 2 recording formats, VIDEO mode and VR mode, for DVD-RW.

** Finalizing is required to play the disc in a DVD drive on a computer. A DVD+RW that is not finalized may cause the computer to malfunction.

Recording time of movies

Approximate recordable time in minutes on the internal memory (HDR-UX20) and one side of a disc. Recordable time differs depending on the setting of [REC MODE] (p. 86).

() : the minimum recording time

Media type	Internal memory (HDR-UX20)	DVD-RW/ DVD+RW/DVD-R	DVD+R DL
HD (high definition) image quality			
AVC HD 16M (FH) [*] (highest quality)	55 (55)	–	–
AVC HD 14M (FS) [*] (highest quality)	–	11 (11)	21 (21)
AVC HD 9M (HQ) ^{**} (high quality)	115 (80)	20 (14)	35 (26)
AVC HD 7M (SP) ^{**} (standard quality)	140 (100)	25 (18)	45 (34)
AVC HD 5M (LP) ^{**} (long play)	180 (145)	32 (26)	60 (49)
SD (standard definition) image quality			
SD 9M (HQ) (high quality)	115 (100)	20 (18)	35 (32)
SD 6M (SP) (standard quality)	170 (100)	30 (18)	55 (32)
SD 3M (LP) (long play)	325 (215)	60 (44)	110 (80)

^{*} Record “1920 × 1080/60i” of the AVCHD format.

^{**} Record “1440 × 1080/60i” of the AVCHD format.

Notes

- The aspect ratio of images recorded with HD (high definition) image quality is 16:9 (wide).

Tips

- Figures such as 16M and 14M in the table show the average bit rate. M stands for Mbps.
- You can confirm the current recordable time with [MEDIA INFO] (p. 78).
- If you use a double-sided disc, you can record on both sides of the disc (p. 127).
- For details on recordable time for movies on the “Memory Stick PRO Duo,” see page 33.

Your camcorder uses the VBR (Variable Bit Rate) format to automatically adjust image quality to suit the recording scene. This technology causes fluctuations in the recording time. Movies containing quickly moving and complex images are recorded at a higher bit rate, and this reduces the overall recording time.

“HOME” and “OPTION”

- Taking advantage of two types of menus

“HOME MENU” - the starting point for operations with your camcorder



► Categories and items of the HOME MENU

(CAMERA) category

Items	Page
MOVIE ^{*1}	39
PHOTO ^{*1}	39
SMTH SLW REC	42

(VIEW IMAGES) category

Items	Page
VISUAL INDEX ^{*1}	44
INDEX ^{*1}	47
INDEX ^{*1}	47
PLAYLIST	66

(OTHERS) category

Items	Page
DELETE ^{*2}	57
PHOTO CAPTURE	59
MOVIE DUB	61
PHOTO COPY ^{*3}	63
EDIT	64
PLAYLIST EDIT	65
PRINT	70
USB CONNECT	105
TV CONNECT Guide ^{*1}	50

(MANAGE MEDIA) category

Items	Page
MOVIE MEDIA SET ^{*1}	28
PHOTO MEDIA SET ^{*1*3}	29
FINALIZE ^{*1}	73
MEDIA INFO	78
MEDIA FORMAT ^{*1}	78
UNFINALIZE	80
DISC SELECT GUIDE	81
REPAIR IMG.DB F.	82

(SETTINGS) category^{*1}

To customize your camcorder (p. 84).

^{*1} You can also set these items during Easy Handycam operation (p. 34). For the items available in the (SETTINGS), see page 84.

^{*2} During Easy Handycam operation, you can set this menu item when the setting of [MOVIE MEDIA SET] is assigned to the internal memory (HDR-UX20) or the “Memory Stick.”

^{*3} This function can be used on HDR-UX20.

Using the HOME MENU

- 1 While pressing the green button, slide the POWER switch in the direction of the arrow to turn on the power.

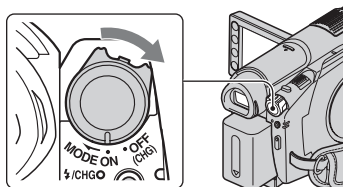

- 2 Press **↑** (HOME) **[A]** (or **[B]**).

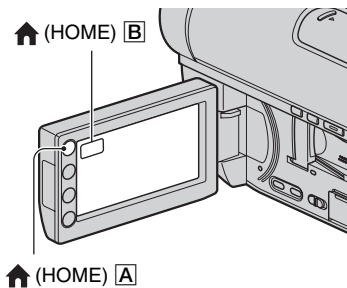

- 3 Touch the desired category.
Example: **[OTHERS]** category

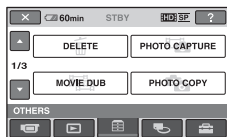

- 4 Touch the desired item.

Example: [EDIT]

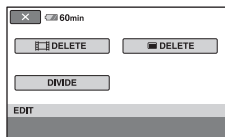

- 5 Follow the guide on the screen for further operation.

To hide the HOME MENU screen

Touch **[X]**.

- ▶ When you want to know something about the function of each item on the HOME MENU - HELP

- 1 Press **↑** (HOME).

The HOME MENU appears.



- 2 Touch **[?]** (HELP).

The bottom of the **[?]** (HELP) turns orange.



3 Touch the item you want to learn more about.



When you touch an item, its explanation appears on the screen.

To apply the option, touch [YES], otherwise, touch [NO].

To deactivate the HELP

Touch [?] (HELP) again in step 2.

Using the OPTION MENU

Just a touch on the screen during shooting or playback displays the functions available at that moment. You will find it easy to make various settings. See page 98 for further details.

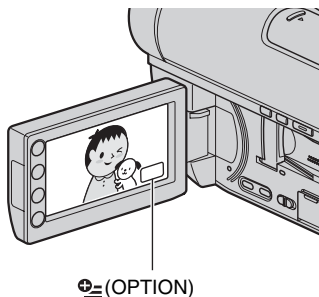

Step 1: Checking supplied items

Make sure that you have the following items supplied with your camcorder. The number in the parentheses indicates the number of that item supplied.

AC Adaptor (1) (p. 22)

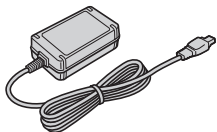

Power cord (Mains lead) (1) (p. 22)



Component A/V cable (1) (p. 51, 53)

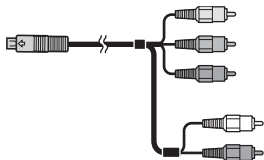

A/V connecting cable (1) (p. 53, 68)



USB cable (1) (p. 69, 70)

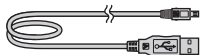

Wireless Remote Commander (1)
(p. 142)



A button-type lithium battery is already installed.

Rechargeable battery pack NP-FH60 (1)
(p. 22)

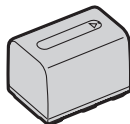

CD-ROM "Handycam Application
Software" (1) (p. 105)

- Picture Motion Browser (Software)
- PMB Guide

"Operating Guide" (This manual) (1)

Step 2: Charging the battery pack

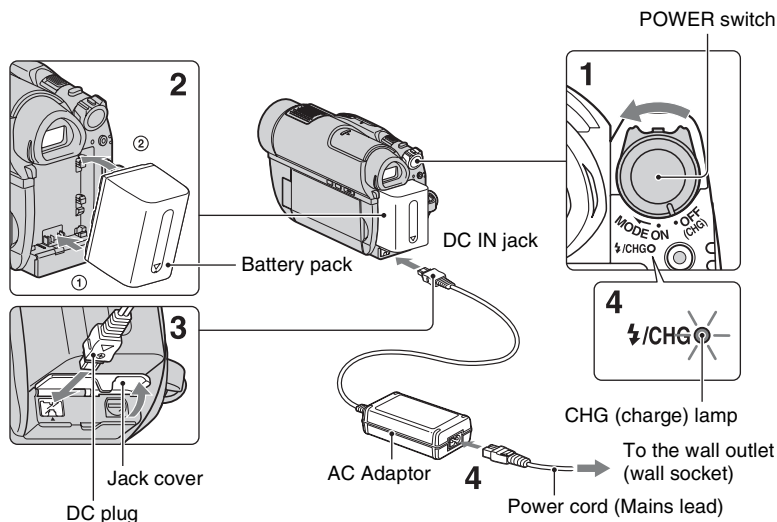

You can charge the “InfoLITHIUM” battery pack (H series) (p. 130) after attaching it to your camcorder.

Notes

- You cannot attach any “InfoLITHIUM” battery pack other than the H series to your camcorder.

1 Slide the POWER switch in the direction of the arrow to OFF (CHG) (The default setting).

2 Align the terminals of the battery pack and your camcorder (①), then attach the battery pack in the direction of the arrow until it clicks (②).

3 Connect the AC Adaptor to the DC IN jack of your camcorder.

Open the jack cover, and connect the DC plug of the AC Adaptor. Make sure that the ▲ mark on the DC plug is facing to the ▲ mark on your camcorder.

4 Connect the power cord (mains lead) to the AC Adaptor and the wall outlet (wall socket).

The CHG (charge) lamp lights up and charging starts. The CHG (charge) lamp turns off when the battery is fully charged.

5 After charging the battery pack, disconnect the AC Adaptor from the DC IN jack on your camcorder.

Notes

- Disconnect the AC Adaptor from the DC IN jack holding both the camcorder and the DC plug.



To remove the battery pack

- ① Slide the POWER switch to OFF (CHG).
- ② Press and hold the BATT (battery release) button and remove the battery pack in the direction of the arrow.

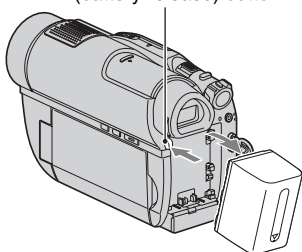
BATT (battery release) button



Notes

- When you remove the battery pack or disconnect the AC Adaptor, make sure that the  (Movie) lamp/  (Still) lamp (p. 25)/ ACCESS lamp (p. 30)/access lamp (p. 32) is turned off.
- When storing the battery pack, fully discharge the battery pack before storing it for an extended period (see page 131 for the details of storage).

To use a power source from a wall outlet (wall socket)

Make the same connections as you do when charging the battery pack. The battery pack will not lose its charge in this case.

To check the remaining battery (Battery Info)

Set the POWER switch to OFF (CHG), then press DISP/BATT INFO.

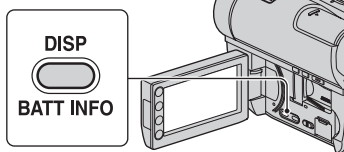

After a while, the approximate recordable time and battery information appear for about 7 seconds. You can view the battery information for up to 20 seconds by pressing DISP/BATT INFO again while the information is displayed.

Remaining battery (approx.)

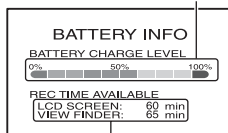

Recording capacity (approx.)

Charging time

Approximate time (min.) required when you fully charge a fully discharged battery pack.

Battery pack	Charging time
NP-FH50	135
NP-FH60 (supplied)	135
NP-FH70	170
NP-FH100	390

Available recording time

Approximate time (min.) available when you use a fully charged battery pack.

“HD” stands for high definition image quality, and “SD” stands for standard image quality.

Step 2: Charging the battery pack (Continued)

When the media is set to the internal memory (HDR-UX20) or the "Memory Stick PRO Duo":

Battery pack	Continuous recording time		Typical recording time*	
	HD	SD	HD	SD
Image quality				
NP-FH50	70	90	35	45
	75	95	40	50
NP-FH60	95	120	50	60
(supplied)	100	130	50	65
NP-FH70	150	195	80	100
	160	205	85	105
NP-FH100	350	440	180	230
	370	470	190	245

When the media is set to the disc:

Battery pack	Continuous recording time		Typical recording time*	
	HD	SD	HD	SD
Image quality				
NP-FH50	60	80	30	40
	65	85	35	45
NP-FH60	80	105	40	55
(supplied)	90	115	45	60
NP-FH70	130	170	65	90
	140	185	70	95
NP-FH100	305	385	160	200
	325	415	170	215

* Typical recording time shows the time when you repeat recording start/stop, turning the power on/off and zooming.

🔊 Notes

- For details on how to set the media, see page 28.
- All times measured when [REC MODE] is set to [HD SP]/[SD SP] under the following conditions:
Top: When the LCD backlight turns on.
Bottom: When recording with the viewfinder while the LCD panel is closed.

Available Playback time

Approximate time (min.) available when you use a fully charged battery pack.

"HD" stands for high definition image quality, and "SD" stands for standard image quality.

When the media is set to the internal memory (HDR-UX20) or the "Memory Stick PRO Duo":

Battery pack	LCD panel opened*		LCD panel closed	
	HD	SD	HD	SD
Image quality				
NP-FH50	110	125	120	135
NP-FH60	145	165	160	180
(supplied)				
NP-FH70	235	270	255	290
NP-FH100	535	600	580	650

When the media is set to the disc:



Battery pack	LCD panel opened*		LCD panel closed	
	HD	SD	HD	SD
Image quality				
NP-FH50	90	100	100	115
NP-FH60	120	135	130	150
(supplied)				
NP-FH70	195	220	215	245
NP-FH100	440	500	485	555

* When the LCD backlight is on.

🔊 Notes

- For details on how to set the media, see page 28.

On the battery pack

- Before changing the battery pack, slide the POWER switch to OFF (CHG) and turn off the  (Movie) /  (Still) lamps (p. 25) or the ACCESS lamp (p. 30) / access lamp (p. 32).
- The  /CHG (flash/charge) lamp flashes during charging, or Battery Info (p. 23) will not be correctly displayed under the following conditions:
 - The battery pack is not attached correctly.
 - The battery pack is damaged.
 - The battery pack is worn-out (For Battery Info only).

- The power will not be supplied from the battery as long as the AC Adaptor is connected to the DC IN jack of your camcorder, even when the power cord (mains lead) is disconnected from the wall outlet (wall socket).
- When attaching an optional video light, it is recommended that you use an NP-FH70 or NP-FH100 battery pack.
- We do not recommend using an NP-FH30, which only allows short recording and playback times, with your camcorder.

On the charging/recording/playback time

- Times measured when using the camcorder at 25 °C (77 °F) (10 °C to 30 °C (50 °F to 86 °F) is recommended).
- The recording and playback time will be shorter when you use your camcorder in low temperatures.
- The recording and playback time will be shorter depending on the conditions under which you use your camcorder.

On the AC Adaptor

- Use the nearby wall outlet (wall socket) when using the AC Adaptor. Disconnect the AC Adaptor from the wall outlet (wall socket) immediately if any malfunction occurs while using your camcorder.
- Do not use the AC Adaptor placed in a narrow space, such as between a wall and furniture.
- Do not short-circuit the DC plug of the AC Adaptor or battery terminal with any metallic objects. This may cause a malfunction.
- Even if your camcorder is turned off, AC power (mains) is still supplied to it while connected to the wall outlet (wall socket) via the AC Adaptor.

Step 3: Turning the power on and setting the date and time

Set the date and time when using this camcorder for the first time. If you do not set the date and time, the [CLOCK SET] screen appears every time you turn on your camcorder or change the POWER switch position.

Touch the button on the LCD screen.

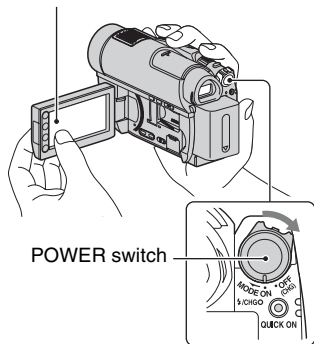



- 1 While pressing the green button, slide the POWER switch repeatedly in the direction of the arrow until the respective lamp lights up.

 (Movie): To record movies

 (Still): To record still images

When turning your camcorder on for the first time, go to step 3.

- 2 Touch  (HOME) →  (SETTINGS) → [CLOCK/  LANG] → [CLOCK SET].

The [CLOCK SET] screen appears.



Step 3: Turning the power on and setting the date and time (Continued)

3 Select the desired geographical area with /, then touch [NEXT].

4 Set [DST SET] or [SUMMERTIME], then touch [NEXT].

5 Set [Y] (year) with /.



6 Select [M] with /, then set the month with /.

7 Set [D] (day), hour and minute in the same way, then touch [NEXT].

8 Make sure that the clock is correctly set, then touch [OK].

The clock starts.

You can set any year up to the year 2037.

For midnight, set it to 12:00 AM.

For midday, set it to 12:00 PM.

Notes

- If you do not use your camcorder for **about 3 months**, the built-in rechargeable battery gets discharged and the date and time settings may be cleared from the memory. In that case, charge the built-in rechargeable battery and then set the date and time again (p. 134).
- It takes a few seconds for your camcorder to be ready to shoot after the power is turned on. You cannot operate your camcorder during this time.
- The lens cover opens automatically when the power is turned on. It closes when the playback screen is selected, or the power is turned off.
- In the setting at the time of purchase, the power turns off automatically if you leave your camcorder without any operation attempted for approximately 5 minutes, to save battery power ([A.SHUT OFF], p. 97).

Tips

- The date and time does not appear during recording, but they are automatically recorded on the media, and can be displayed during playback ([DATA CODE], p. 92).
- Refer to page 125 for information concerning "World time difference."
- If the buttons on the touch panel do not work correctly, adjust the touch panel (CALIBRATION) (p. 132).

Changing the language setting

You can change the on-screen displays to show messages in a specified language. To select the screen language, touch (HOME) → (SETTINGS) → [CLOCK/LANG] → [LANGUAGE SET] (p. 96).

To turn off the power

Slide the POWER switch to OFF (CHG).

Step 4: Making adjustments before recording

Adjusting the LCD panel

Open the LCD panel 90 degrees to the camcorder (①), then rotate it to the best angle to record or play (②).

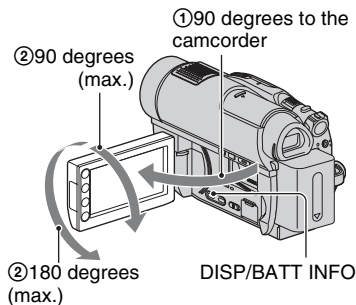

To turn off the LCD backlight to make the battery last longer

Press and hold DISP/BATT INFO for a few seconds until OFF appears.

This setting is practical when you use your camcorder in bright conditions or you want to save battery power. The recorded image will not be affected by the setting. To turn on the LCD backlight, press and hold DISP/BATT INFO for a few seconds until OFF disappears.

Notes

- Do not press the buttons on the LCD frame accidentally when you open or adjust the LCD panel.

Tips

- If you open the LCD panel 90 degrees to the camcorder, then rotate it 180 degrees to the lens side, you can close the LCD panel with the LCD screen facing out. This is convenient during playback operations.
- Touch HOME (HOME) \rightarrow SETTINGS (SETTINGS) \rightarrow [SOUND/DISP SET] \rightarrow [LCD BRIGHT] (p. 93) to adjust the brightness of the LCD screen.
- The information is displayed or hidden (display \leftrightarrow no display) each time you press DISP/BATT INFO.

Adjusting the viewfinder

You can view images using the viewfinder with the LCD panel closed to avoid wearing down the battery, or when the image seen on the LCD screen is poor.

Pull out the viewfinder, then place your eyes on the viewfinder to watch images. Adjust the viewfinder for clear viewing according to your eye site.

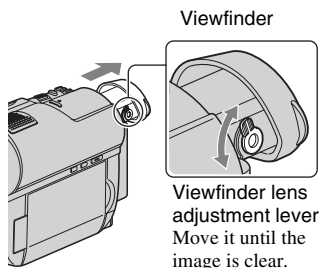

Tips

- You can adjust the brightness of the viewfinder backlight by touching HOME (HOME) \rightarrow SETTINGS (SETTINGS) \rightarrow [SOUND/DISP SET] \rightarrow [VF B.LIGHT] (p. 94).

Fastening the grip belt

Fasten the grip belt and hold your camcorder correctly.

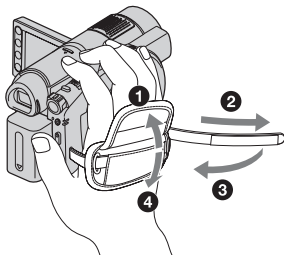

Step 5: Selecting the media

You can select the desired media for recording/playback/editing for either movies or still images, according to your needs.

For the media for movies, set the internal memory*/disc/“Memory Stick PRO Duo,” and also set the image quality ([HDI]: (high definition) or [SDI]: (standard definition)). For the media for still images, set the internal memory*/“Memory Stick PRO Duo.” The default settings are shown below.

HDR-UX10:

Movie: Disc

Still image: “Memory Stick PRO Duo”**

HDR-UX20:

Movie: Internal memory

Still image: Internal memory

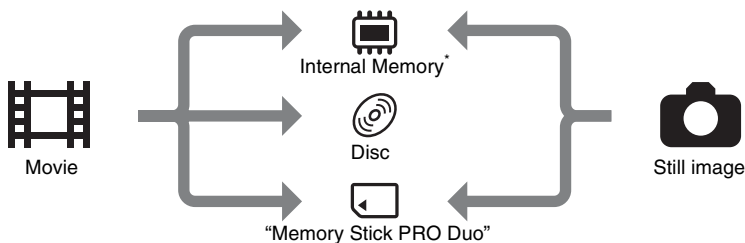

* HDR-UX20

** For HDR-UX10, the media for still images is fixed to “Memory Stick PRO Duo.”

Selecting the media for movies

- 1 Touch **HOME** → **MANAGE MEDIA** → **[MOVIE MEDIA SET]**.

The select screen of the media for movies is displayed.

- 2 Touch the desired image quality and media.

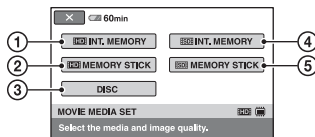

- 1 **[HDI] INT. MEMORY** (HDR-UX20)

Media: Internal memory

Image quality: HD (high definition)

- 2 **[HDI] MEMORY STICK**
Media: “Memory Stick PRO Duo”
Image quality: HD (high definition)

- 3 **[DISC]**
Media: Disc
Image quality: HD (high definition) or SD (standard definition)
The image quality will be selected in “Step 6” (p. 30).

- 4 **[SDI] INT. MEMORY** (HDR-UX20)
Media: Internal memory
Image quality: SD (standard definition)

- 5 **[SDI] MEMORY STICK**
Media: “Memory Stick PRO Duo”
Image quality: SD (standard definition)

- 3 Touch **[YES]**.

4 When [Completed.] appears, touch .

The media for movies is now set.

Selecting the media for still images (HDR-UX20)

1 Touch (HOME) → (MANAGE MEDIA) → [PHOTO MEDIA SET].

The select screen of the media for still images is displayed.

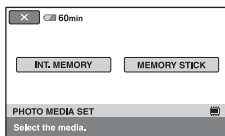

2 Touch the desired media.

Notes

- You cannot select the disc as the media for still images.



3 Touch [YES].

4 When [Completed.] appears, touch .

The media for still images is now set.

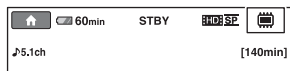
- Confirm the media icon displayed at the upper right of the screen.





	Internal memory (HDR-UX20)
	Disc The icon displayed on the screen varies, depending on the disc used (p. 9).
	"Memory Stick PRO Duo"

Tips

- For recording/playback/editing on the other media, change the media setting.

To confirm the media setting

- Slide the POWER switch repeatedly until the respective lamp ( (Movie)/  (Still)) lights up.

Step 6: Inserting a disc or a “Memory Stick PRO Duo”

When recording images by setting the media to the internal memory (HDR-UX20) in “Step 5,” you do not need to perform the procedure in “Step 6.”

Disc

When you set the media to [DISC] in “Step 5”, a new 8 cm DVD-RW, DVD+RW, DVD-R, or DVD+R DL is required for recording (p. 16).

Notes

- Remove dust or fingerprints from the disc beforehand, using a soft cloth (p. 128).

1 Check that the power of your camcorder is on.

2 Slide the disc cover OPEN switch in the direction of the arrow (OPEN →).

[PREPARING TO OPEN] appears on the LCD screen, then the disc cover opens slightly, automatically.

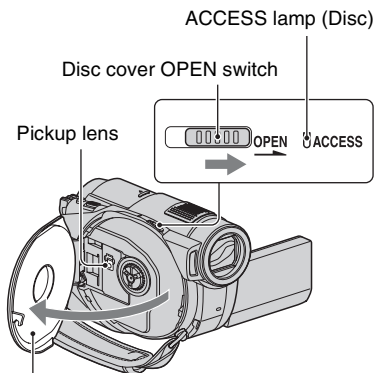

When the disc cover opens slightly, open it further.

3 Set the disc with the recording side facing your camcorder, then press the center of the disc until it clicks.

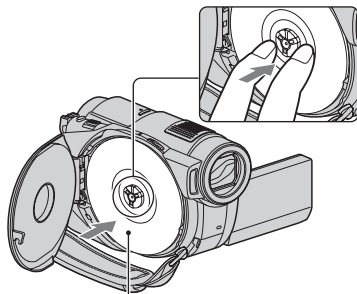

Set the disc with the label side facing out when using a single-sided disc.

4 Close the disc cover.

[DISC ACCESS] appears on the LCD screen.

It may take some time for the camcorder to recognize the disc, depending on the disc type and condition.

Skip to step 7 when you use a DVD-R/ DVD+R DL.

5 When you use a DVD-RW/ DVD+RW, touch [Use DISC SELECT GUIDE].

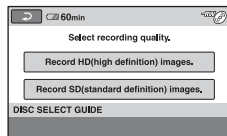

Notes

- You cannot use [Use DISC SELECT GUIDE] during Easy Handycam operation (p. 34). Format the disc, following the instructions on the screen.

6 Touch [Record HD (high definition) images.].

Touch [Record SD (standard definition) images.] to record with SD (standard definition) image quality.

Items displayed vary depending on the status of your camcorder, or the type of disc inserted.

7 Touch the option that is right for you on the screen.

The disc will be formatted with the image recording quality you selected. When the formatting is completed, you can start recording on the disc.

If you select SD (standard definition) image quality

- When you use a DVD-RW, select a recording format, [VIDEO] or [VR], (p. 16). If you format a disc during Easy Handycam operation (p. 34), the recording format is fixed to [VIDEO].
- When you use a DVD+RW, select the aspect ratio, [16:9 WIDE] or [4:3].

To remove the disc

- Perform steps 1 and 2 to open the disc cover.
- While holding the disc fastener at the center, tip up the edge of the disc.

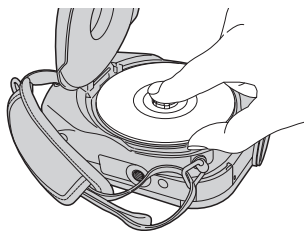

Notes

- You cannot change the image quality (HD (high definition) or SD (standard definition), p. 16) of a disc midway.
- Be careful not to obstruct the operation with your hand or other objects, etc., when opening or closing the disc cover. Move the belt to the bottom of the camcorder, then open or close the disc cover.
- If you catch the belt when closing the disc cover, it may cause your camcorder to malfunction.
- Do not touch the recording side of the disc or pickup lens (p. 133). When using a double-sided disc, take care not to smudge the surface with fingerprints.
- If you close the disc cover with the disc set incorrectly, it may cause your camcorder to malfunction.
- Do not disconnect the power sources during formatting.
- Do not apply shock or vibration to your camcorder:
 - while the ACCESS lamp is on
 - while the ACCESS lamp is flashing
 - while [DISC ACCESS] or [PREPARING TO OPEN] is displayed on the screen
- It may take some time to remove the disc depending on the disc condition or recorded materials.
- It may take up to 10 minutes to remove a disc if it is damaged or is dirty with fingerprints, etc. In that case, the disc might be damaged.

Tips

- You can remove the disc when a power source is connected to your camcorder even when your camcorder is turned off. However, the disc recognition process (step 4) does not start.

Step 6: Inserting a disc or a “Memory Stick PRO Duo” (Continued)

- To delete all of the previously recorded images from a DVD-RW/DVD+RW, then to use it again to record new images, see “Formatting the media” on page 78.
- You can check the right disc using [DISC SELECT GUIDE] on the HOME MENU (p. 81).

“Memory Stick PRO Duo”

When you set the media to “Memory Stick” in “Step 5,” a “Memory Stick PRO Duo” is required for recording. For details on the “Memory Stick” compatible with the camcorder, see page 6.

💡 Tips

- To record only still images on the “Memory Stick PRO Duo,” you do not need perform the procedure after step 3.

1 Open the LCD panel.

2 Insert the “Memory Stick PRO Duo.”

- 1 Open the Memory Stick Duo cover in the direction of the arrow.
- 2 Insert the “Memory Stick PRO Duo” into the Memory Stick Duo slot in the right direction until it clicks.
- 3 Close the Memory Stick Duo cover.

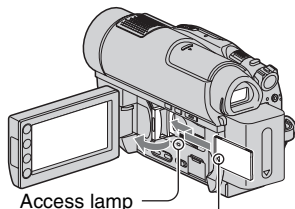

Face the ◀ mark to the LCD screen of the camcorder.

3 When the media for movies is set to either [HDD] MEMORY STICK or [HSD] MEMORY STICK in “Step 5,” slide the POWER switch to light up the [Movie] lamp.

If the POWER switch is set to OFF (CHG), turn it on while pressing the green button.

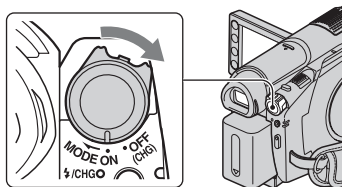

The [Create a new Image Database File.] screen appears on the LCD screen when you insert a new “Memory Stick PRO Duo.”

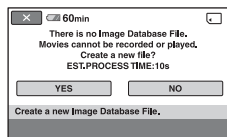

4 Touch [YES].

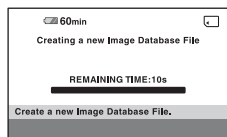

To eject the “Memory Stick PRO Duo”

Open the LCD panel and Memory Stick Duo cover, then lightly push on the “Memory Stick PRO Duo” in once and slide out it alongside the camcorder body.

Notes

- To prevent the media from being broken or recorded images from being lost, do not do the following when the access lamp (p. 32) is lit or flashing:
 - To remove the battery pack or AC Adaptor
 - To shake or knock your camcorder
 - To eject the “Memory Stick PRO Duo”
- Do not open the Memory Stick Duo cover during recording.
- If you force the “Memory Stick PRO Duo” into the slot in the wrong direction, the “Memory Stick PRO Duo,” the Memory Stick Duo slot, or image data may be damaged.
- If [Failed to create a new Image Database File. It may be possible that there is not enough free space.] is displayed on step 4, format the “Memory Stick PRO Duo” (p. 78). Note that formatting will delete all data recorded on the “Memory Stick PRO Duo.”
- Do not pinch and eject the “Memory Stick PRO Duo” forcibly. It may cause a malfunction.

Capacity of a “Memory Stick PRO Duo” and the available recording time of movies

Approximate recordable time in minutes. Figures () are minimum recording time.

HD (high definition) image quality:

	AVC HD 16M (FH)	AVC HD 9M (HQ)	AVC HD 7M (SP)	AVC HD 5M (LP)
1GB	6 (6)	10 (9)	15 (10)	20 (15)
2GB	10 (10)	25 (20)	30 (20)	40 (35)
4GB	25 (25)	55 (40)	65 (45)	85 (70)
8GB	55 (55)	115 (80)	140 (100)	180 (145)

SD (standard definition) image quality:

	SD 9M (HQ)	SD 6M (SP)	SD 3M (LP)
1GB	10 (10)	20 (10)	35 (25)
2GB	25 (25)	40 (25)	80 (50)
4GB	55 (50)	80 (50)	160 (105)
8GB	115 (100)	170 (100)	325 (215)

Notes

- Numbers in the table are of when using a “Memory Stick PRO Duo” made by Sony Corporation. The recordable time varies depending on the recording conditions, the type of “Memory Stick,” or the [REC MODE] setting (p. 86).

Tips

- For the recordable number of still images, see page 91.



Recording and playback with ease (Easy Handycam operation)

Easy Handycam operation makes nearly all settings automatic so that you can perform recording or playback operations without detailed settings. It also makes the screen font size larger for easy viewing. The images are recorded on the set media (p. 28).

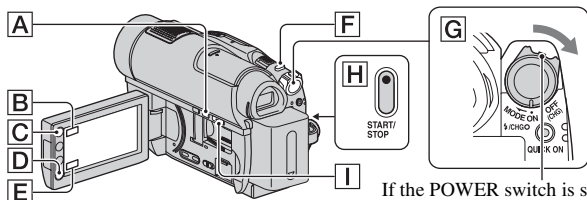

If the POWER switch is set to OFF (CHG), slide it while pressing the green button.

Recording movies



- Slide the POWER switch **G** in the direction of the arrow until the (Movie) lamp lights up.



- Press EASY **A**.

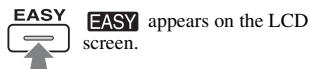

Recording still images



- Slide the POWER switch **G** in the direction of the arrow until the (Still) lamp lights up.



- Press EASY **A**.

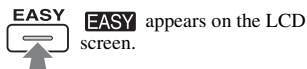

- Press START/STOP **H** or **D** to start recording.*

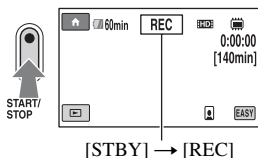

To stop recording, press START/STOP again.

- Press PHOTO **F** lightly to adjust the focus **A** (a beep sounds), then press it fully **B** (a shutter click sounds).

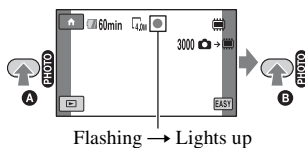

* The setting of [REC MODE] (p. 86) is fixed to [HD SP] or [SD SP].

Tips

- During Easy Handycam operation, a frame appears on a face of person ([FACE DETECTION], p. 89).

Playing back recorded movies/still images

1 Slide the POWER switch **[G]** to turn on your camcorder.

2 Press **[VIEW IMAGES]** **[I]** or **[E]**.

The VISUAL INDEX screen appears on the LCD screen (It may take some time to display the thumbnails).

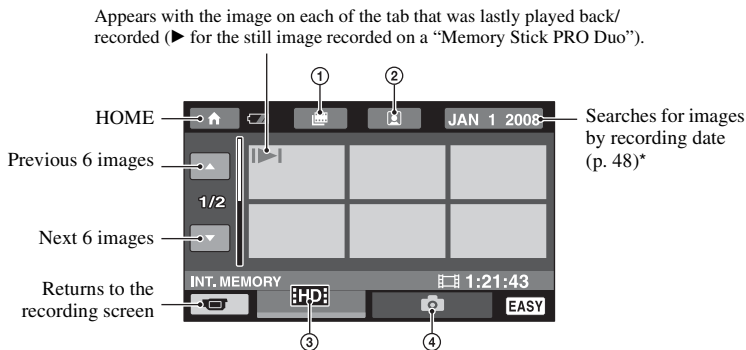

① **[CAMERA]** : Goes to the Film Roll Index screen (p. 47).

② **[FACE]** : Goes to the Face Index screen (p. 47).

③ **[HD]** : Displays the movies with HD (high definition) image quality.

When SD (standard definition) image quality is selected on [MOVIE MEDIA SET] (p. 28), **[SD]** is displayed. When [DISC] is selected, **[DISC]** is displayed.

④ **[CAMERA]** : Displays the still images

* You cannot search for the desired movie by recording date when you set [DISC] on [MOVIE MEDIA SET] (p. 28).

Recording and playback with ease (Easy Handycam operation) (Continued)

3 Start playback.

Movies:

Touch the **[HDI]**, **[HSD]** or **[HDI]** tab and the movie to be played back.

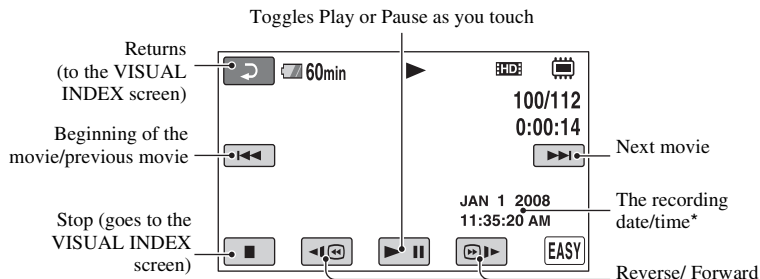

* The setting of [DATA CODE] is fixed to [DATE/TIME] (p. 92).

Tips

- When playback from the selected movie reaches the last movie, the screen returns to the VISUAL INDEX screen.
- You can slow down the playback speed by touching **[<|>]** / **[<|>]** during pause.
- You can adjust the sound volume by touching **[HOME]** → **[SETTINGS]** → **[SOUND SETTINGS]** → **[VOLUME]**, then touch **[−]** / **[+]**.
- To switch the media for movies, set the media on **[MOVIE MEDIA SET]** (p. 28).

Still images:

Touch the **[CAMERA]** tab and the still image to be played back.

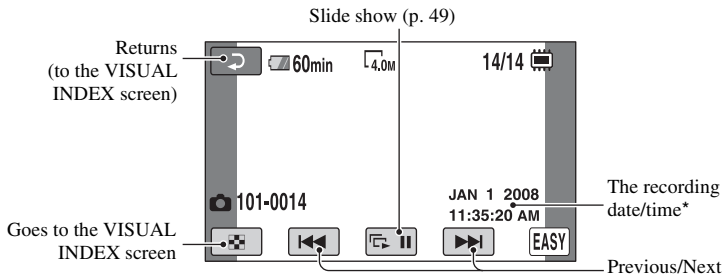

* The setting of [DATA CODE] is fixed to [DATE/TIME] (p. 92).

Tips

- To switch the media for still images, set the media on **[PHOTO MEDIA SET]** (HDR-UX20) (p. 29).

To cancel Easy Handycam operation

Press EASY **[A]** again. **EASY** disappears from the screen.

Menu settings during Easy Handycam operation

Press **[HOME]** **[B]** or **[C]** to display the menu items available for setup changes (p. 18, 84).

Notes

- Most of the menu items automatically return to the default settings. The settings of some menu items are fixed. For details, see page 109.
- When formatting DVD-RW discs with SD (standard definition) image quality, the recording format is fixed to VIDEO (p. 16).
- You cannot set the **[OPTION]** menu.
- Cancel Easy Handycam operation if you want to add effects to images or change settings.

Invalid buttons during Easy Handycam operation

You cannot use some buttons/functions during Easy Handycam operation since they are automatically set (p. 109). If you set an invalid operation, [Invalid during Easy Handycam operation.] may appear on the screen.

To make the disc compatible with playback on other devices (Finalizing)

You need to finalize a recorded disc to make it compatible with playback on other devices or computers. See page 73 on finalizing operation.

Notes

- You cannot make additional recordings on DVD-R/DVD+R DL discs once you finalize the disc, even if there is free space on the disc.
- You cannot record additional materials on a finalized disc during Easy Handycam operation (p. 80).

Recording

The images are recorded on the set media (p. 28). The default settings are shown below.

HDR-UX10:

HDR-UX20:

Movie: Disc

Movie: Internal memory

Still image: "Memory Stick PRO Duo"

Still image: Internal memory

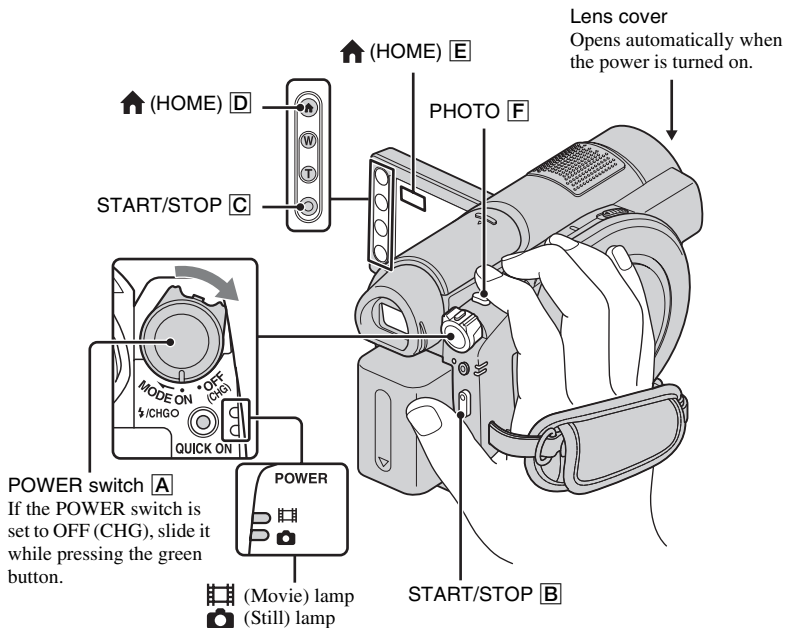

Notes

- If the ACCESS lamp (p. 30)/access lamp (p. 32) is lit or flashing after recording is finished, it means data is still being written onto the media. Do not apply shock or vibration to your camcorder, and do not remove the battery or AC Adaptor. Also, do not eject the "Memory Stick PRO Duo" from your camcorder.
- When a movie file exceeds 2 GB with setting the media to the internal memory (HDR-UX20) or the "Memory Stick" (p. 28), the next movie file is created automatically.

Tips

- On the "Memory Stick" you can use with your camcorder, see page 6.
- You can check the available recording time and memory usage of the media by touching **HOME (HOME) D** (or **E**) → **MANAGE MEDIA** → **[MEDIA INFO]** (p. 78).

Recording movies



1 Slide the POWER switch **A** in the direction of the arrow to light up the (Movie) lamp.

2 Press START/STOP **B** (or **C**).

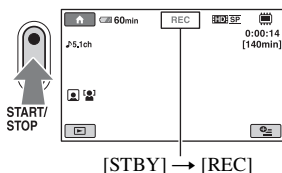

To stop recording, press START/STOP again.

Recording still images



1 Slide the POWER switch **A** in the direction of the arrow to light up the (Still) lamp.

2 Press PHOTO **F** lightly to adjust the focus **A** (a beep sounds), then press it fully **B** (a shutter click sounds).

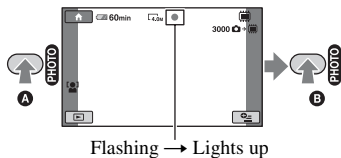

The red appears beside or . When the red disappears, the image has been recorded.

Notes

- You cannot record still images on a disc.

Tips

- For details on the recordable time for movies, see page 17, 33, and on the number of recordable still images, see page 91.
- You can record still images by pressing PHOTO **F** (Dual Rec, p. 41) during movie recording.
- A frame is shown on the detected face, and the detected face image is optimized automatically ([FACE DETECTION], p. 89).
- When detecting a face during movie recording, flashes and the face is recorded in the Face Index. When playing back a movie, you can search for desired scenes by face (Face Index, p. 47).
- You can capture still images from a recorded movie (p. 59).
- You can switch the recording mode by touching (HOME) **D** (or **E**) → (CAMERA) → [MOVIE] or [PHOTO].

Zooming

You can magnify images to 15 times the original size with the power zoom lever or the zoom buttons on the LCD frame.

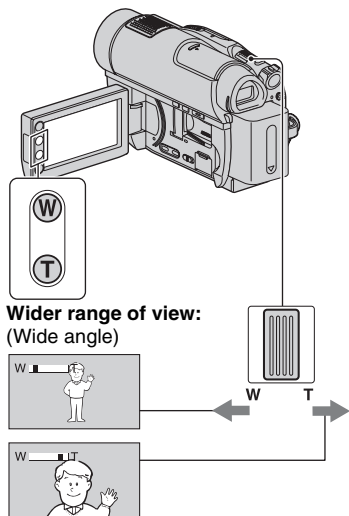

Wider range of view:
(Wide angle)

Close view: (Telephoto)

Move the power zoom lever slightly for a slower zoom. Move it further for a faster zoom.

⚡ Notes

- Be sure to keep your finger on the power zoom lever. If you move your finger off the power zoom lever, the operation sound of the power zoom lever may also be recorded.
- You cannot change the zoom speed with the zoom buttons on the LCD frame.
- The minimum possible distance between camcorder and subject while maintaining sharp focus is about 1 cm (about 13/32 in.) for wide angle and about 80 cm (about 2 5/8 feet) for telephoto.

💡 Tips

- You can set [DIGITAL ZOOM] (p. 87) if you want to zoom to a level greater than 15 ×, when recording movies.

Recording sound with more presence (5.1ch surround recording)

Dolby Digital 5.1ch surround sound can be recorded with the built-in microphone. You can enjoy realistic sound when playing the movies on devices that support 5.1ch surround sound.

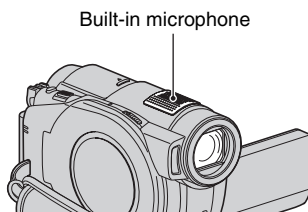

Dolby Digital 5.1 Creator, 5.1ch surround sound
📖 Glossary (p. 145)

⚡ Notes

- To enjoy the 5.1ch surround sound recorded with HD (high definition) image quality, you need an AVCHD format device compatible with 5.1ch surround sound (p. 128).
- When connected to another device compatible with 5.1ch surround sound using the HDMI cable (optional), the movie recorded with HD (high definition) image quality and the 5.1ch sound is automatically output in the 5.1ch sound. The movie recorded with SD (standard definition) image quality is automatically converted to the 2ch sound and output.

💡 Tips

- When recording sound, you can select the desired sound from either [5.1ch SURROUND] or [2ch STEREO] ([AUDIO MODE], p. 86).

Starting recording quickly (QUICK ON)

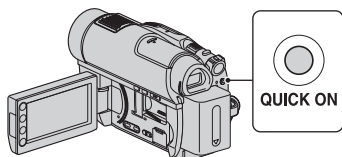

If you press the QUICK ON button, instead of turning off the power, the camcorder becomes power saving status (Sleep mode). While the Sleep mode is set, the QUICK ON button is flashed. To resume the next recording, press the QUICK ON button again. Your camcorder will be ready for recording after about 1 second.

Tips

- While the Sleep mode is set, the power consumption of the camcorder is reduced by about a half when it is compared during recording, and the battery power can be saved.
- When no operation is performed in the Sleep mode, the power is turned off automatically. You can set the desired turn off time of the camcorder with [QUICK ON STBY] (p. 97), when the camcorder is set to the Sleep mode.

Recording high quality still images during movie recording (Dual Rec)

You can record high quality still images by pressing PHOTO while recording a movie. The still images are recorded on the media set on [PHOTO MEDIA SET] (HDR-UX20) (p. 29).

Notes

- You cannot use the flash during Dual Rec.
- When the capacity of the media becomes insufficient, or when a series of still images are recorded, may be displayed. You cannot record still images while is displayed.

Tips

- When the (Movie) lamp is lit, the size of still images becomes [3.0M] (16:9 wide) or [2.2M] (4:3).
- You can record still images during recording standby in the same way as when the (Still) lamp is lit. You can also record with the flash.

Recording in dark places (NightShot)

Infrared port

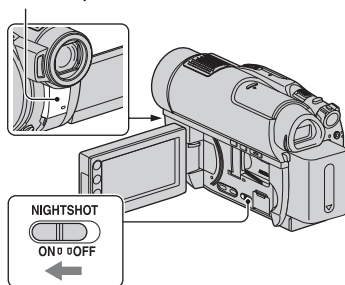

You can record images in dark places to set the NIGHTSHOT switch to ON. () appears.)

Notes



- The NightShot and Super NightShot functions use infrared light. Therefore, do not cover the infrared port with your fingers or other objects.
- Remove the conversion lens (optional).
- Adjust the focus manually ([FOCUS], p. 100) when it is hard to focus automatically.
- Do not use the NightShot and Super NightShot functions in bright places. This may cause a malfunction.

Tips

- To record an image brighter, use Super NightShot function (p. 103). To record an image more faithfully to the original colors, use Color Slow Shutter function (p. 103).

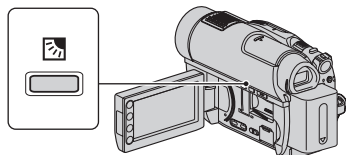
Adjusting the exposure for backlit subjects



To adjust the exposure for backlit subjects, press  (back light) to display  on the LCD screen. To cancel the back light function, press  (back light) again.

Recording in mirror mode

You can record images showing the images to the person to be recorded.

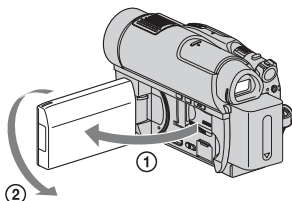



Open the LCD panel 90 degrees to the camcorder (①), then rotate it 180 degrees to the lens side (②).

Tips

- A mirror-image of the subject appears on the LCD screen, but the image will be normal when recorded.
- When recording in mirror mode, a frame does not appear on a face of person ([FACE DETECTION], p. 89).

Recording the fast action in slow-motion (SMTH SLW REC)

Fast moving subjects and actions, which cannot be captured under the ordinary recording conditions, can be recorded in smooth moving slow-motion. This is useful to record fast actions such as a golf or tennis swing.



- ① Press  (HOME) →  (CAMERA) → [SMTH SLW REC].



- ② Press START/STOP.
A 3 second-movie (approx.) is recorded as a 12 second-slow-motion-movie. [Recording...] disappears, when recording is finished.

Touch  to cancel the smooth slow recording.

To change the setting

Touch  (OPTION) →  tab, then select the setting you want to change.

• [TIMING]

Select the recording start point after START/STOP is pressed. The default setting is [3sec AFTER].

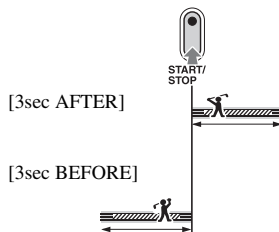

- [RECORD SOUND]

Select [ON] (🔊) to superimpose sounds such as conversation on the slow motion pictures. (The default setting is [OFF].) Your camcorder records sounds for about 12 seconds while [Recording...] is displayed in step ②.

🔊 Notes

- Sounds cannot be recorded while recording a 3 second-movie (approx.).
- Image quality of [SMTH SLW REC] is not as good as that of normal recording.
- If you play back a movie that is recorded when [RECORD SOUND] on [SMTH SLW REC] is set to [OFF], 🎧 is displayed, regardless the setting of [AUDIO MODE] (p. 86).

Playback

Play back the images recorded on the selected media (p. 28). The default settings are shown below.

HDR-UX10:

Movie: Disc

Still image: "Memory Stick PRO Duo"

HDR-UX20:

Movie: Internal memory

Still image: Internal memory

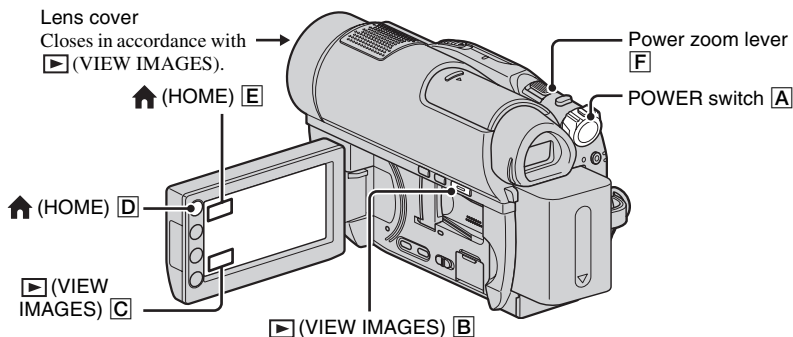

1 Slide the **POWER** switch **[A]** to turn on your camcorder.

2 Press **[VIEW IMAGES]** **[B]** (or **[C]**).

The VISUAL INDEX screen appears on the LCD screen (It may take some time to display the thumbnails).

Appears with the image on each of the tab that was lastly played back/recorded
(▶ for the still image recorded on a "Memory Stick PRO Duo").

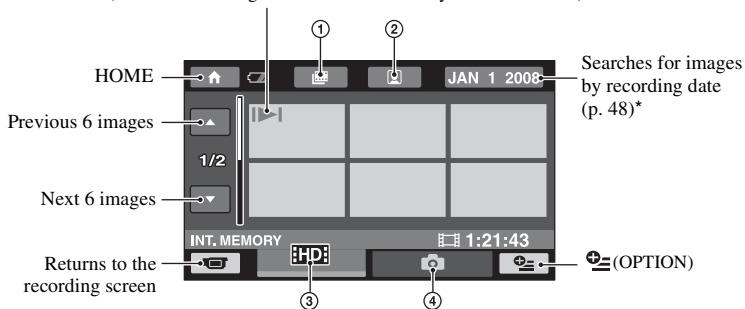

- ① : Goes to the Film Roll Index screen (p. 47).
- ② : Goes to the Face Index screen (p. 47).
- ③ : Displays the movies with HD (high definition) image quality.

When SD (standard definition) image quality is selected on [MOVIE MEDIA SET] (p. 28), is displayed. When [DISC] is selected, is displayed.

- ④ : Displays the still images

* You cannot search for the desired movie by recording date when you set [DISC] on [MOVIE MEDIA SET] (p. 28).

Tips

- The number of the images on the VISUAL INDEX screen can be changed 6 ↔ 12 by moving the power zoom lever . To fix this number, touch (HOME) (or) → (SETTINGS) → [VIEW IMAGES SET] → [DISPLAY] (p. 93).

3 Start playback.

Playing movies

Touch the , or tab and the movie to be played back.

When playback from the selected movie reaches the last movie, the screen returns to the VISUAL INDEX screen.

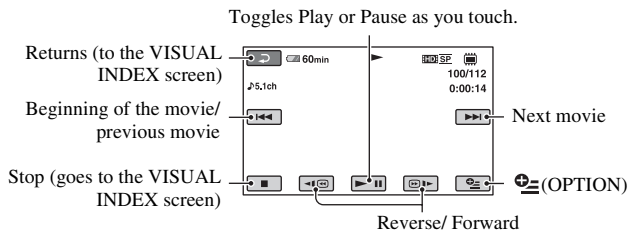

Tips

- Touch / during pause to play back movie slowly.
- When playing back a movie on the internal memory (HDR-UX20) or the “Memory Stick PRO Duo,” a touch of / makes the reverse/fast forward approximately 5 times faster, 2 touches makes it approximately 10 times faster, 3 touches makes it approximately 30 times faster, and 4 touches makes it approximately 60 times faster.
- When playing back a movie on the disc, a touch of / makes the reverse/fast forward approximately 5 times faster, 2 touches makes it approximately 10 times faster (approximately 8 times faster using DVD+RW with SD (standard definition) image quality).

Viewing still images



Touch the tab and the still image to be played back.

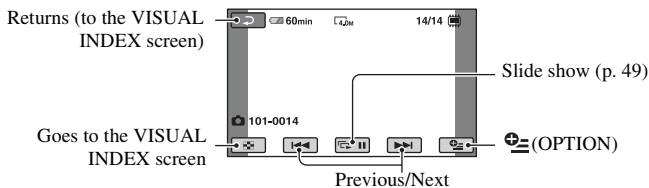

To adjust the sound volume of movies

When playing back a movie, touch (OPTION) → tab → [VOLUME], then adjust the volume with / .

Tips

- You can switch the VISUAL INDEX screen by touching (HOME) (or) → (VIEW IMAGES) → [VISUAL INDEX].

Searching for desired scenes by pinpoint (Film Roll Index)

Movies can be divided by a set time and the first scene of each division is displayed on the index screen. You can start playing back a movie from the selected scene. Set the media that contains the movie to be played back in advance (p. 28).

1 Press (VIEW IMAGES).



The VISUAL INDEX screen appears.

2 Touch (Film Roll Index).

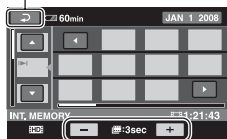
Returns to the VISUAL INDEX screen



Interval setting*





* Select the desired interval for the scene displayed on the screen by pressing  / .

3 Touch to select the desired movie.

4 Touch to search for the desired scene, then touch the thumbnail of the desired scene.

Playback starts from the selected scene.

Tips

- You can display the [ INDEX] (Film Roll Index) screen by touching  (HOME) →  (VIEW IMAGES) → [ INDEX].

Searching for desired scenes by face (Face Index)

The face images detected when recording are displayed on the index screen. You can play back the movie from the scene of the selected face image. Set the media that contains the movie to be played back in advance (p. 28).

1 Press (VIEW IMAGES).

The VISUAL INDEX screen appears.

2 Touch (Face Index).

Returns to the VISUAL INDEX screen

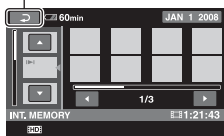

3 Touch to select the desired movie.

4 Touch to search for the desired face image, then touch the thumbnail of the desired face image.

Playback starts from the scene of the selected face image.

Notes

- Faces may not be detected depending on the recording condition.
Example: People wearing glasses or hats, or those who do not face towards the camera.

Playback (Continued)

- Set [INDEX SET] to [ON] before recording to search for a movie from the [INDEX] (Face Index) screen (the default setting) (p. 89). When a face image is recorded in the Face Index during movie recording, [] lights up.

💡 Tips

- You can display the [INDEX] (Face Index) screen by touching [HOME] → [VIEW IMAGES] → [INDEX].

Searching for desired images by date (Date Index)

You can search for desired images by date efficiently. Set the media that contains the image to be played back in advance (p. 28).

📌 Notes

- You cannot use the Date Index of movies recorded on either a disc or of still images recorded on a "Memory Stick PRO Duo."

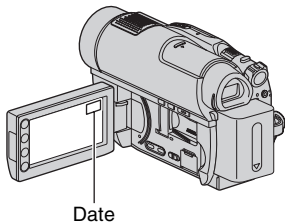

1 Press [VIEW IMAGES].

The VISUAL INDEX screen appears.

2 To search for movies, touch the [M] or [SD] tab. To search for still images, touch the [] tab.

3 Touch the date on the screen.

The recording dates of images are displayed on the screen.

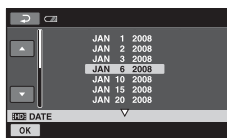

4 Touch []/[] to select the date of the desired image, then touch

[OK].

The images recorded on the selected date are displayed.

💡 Tips

- You can use the Date Index function on the Film Roll Index screen or the Face Index screen by performing step 3 and step 4.

Using PB zoom

You can magnify still images from about 1.1 to 5 times the original size. Magnification can be adjusted with the power zoom lever or the zoom buttons on the LCD frame.

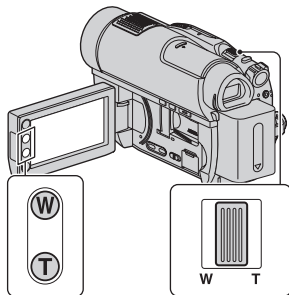



- ① Play back the still images you want to magnify.
- ② Magnify the still image with T (Telephoto). The screen is framed.

- ③ Touch the screen at the point you want to display in the center of the displayed frame.
- ④ Adjust the magnification with W (Wide angle)/T (Telephoto).

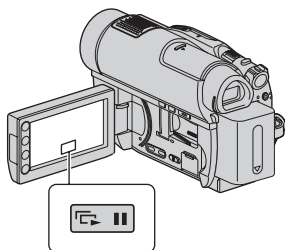

To cancel, touch .

Play back a series of still images (Slide show)



Touch  on the still image playback screen.





The slide show begins from the selected image.

Touch  to stop the slide show. To restart, touch  again.

Notes

- You cannot operate playback zoom during slide show.

Tips

- You can also play back the slide show by touching  (OPTION) →  tab → [SLIDE SHOW] on the VISUAL INDEX screen.
- While playing back a still image, you can set continuous slide show playback by touching  (OPTION) →  tab → [SLIDE SHOW SET]. When [SLIDE SHOW SET] is set to [ON] (the default setting),  appear on the screen and the slide show is played back repeatedly. When setting to [OFF], all of the still images are played back once from the selected image and then the slide show stops.

Playing the image on a TV

Connection methods and quality of the image (HD (high definition)/SD (standard definition)) viewed on the TV screen differ depending on what type of TV is connected, and the connectors used.

Use the supplied AC Adaptor as the power source (p. 22).

Refer also to the instruction manuals supplied with the device to be connected.

Notes

- When recording, set [X.V.COLOR] to [ON] to play back on an x.v.Color-compliant TV (p. 87). Some settings may need to be adjusted on the TV when playing back. Refer to the instruction manual of your TV for details.

Operation flow

You can connect your camcorder to the TV easily following the instructions displayed on the LCD screen, [TV CONNECT Guide].

Switch the input on the TV to the connected jack.

Refer to the instruction manuals of the TV.

↓
Connect your camcorder and TV referring to [TV CONNECT Guide].

↓
Make the required output settings on your camcorder (p. 51, 52).

Playing the image on a TV (Continued)

Jacks on your camcorder

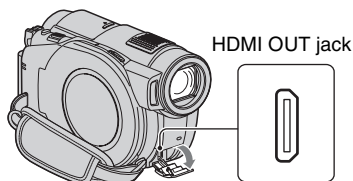
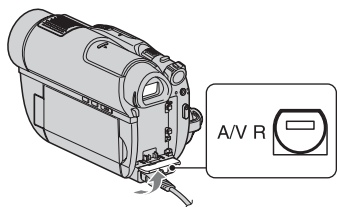

Open the jack cover and connect the cable.





Meanwhile, you can make the relevant connection between your camcorder and the TV.

Selecting the most advantageous connection (TV CONNECT Guide)

Your camcorder will advise you of the most advantageous way of connecting your TV.

-
- 1** Touch  (HOME) →  (OTHERS) → [TV CONNECT Guide].

If the item is not on the screen, touch  /  to change the page.

-
- 2** Touch the answer to the question displayed on the screen.

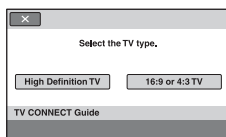

Connecting to a high definition TV

Images recorded with HD (high definition) image quality are played back with HD (high definition) image quality. Images recorded with SD (standard definition) image quality are played back with SD (standard definition) image quality.

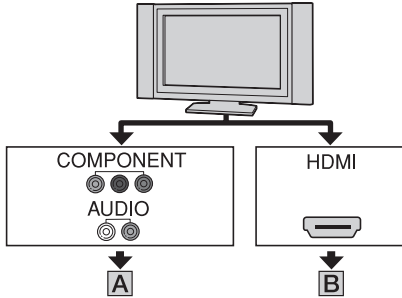

: Signal flow

Type	Camcorder	Cable	TV	HOME MENU setting
------	-----------	-------	----	-------------------

A

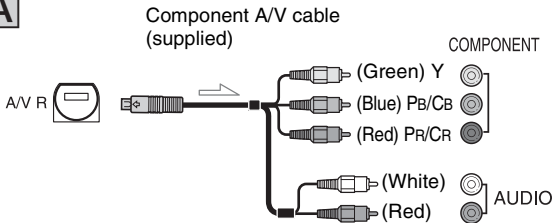

(SETTINGS) →
[OUTPUT SETTINGS]
→ [COMPONENT] →
[1080i/480i] (p. 95)

- When the component plugs are connected, audio signals are not output. To output audio signals, connect the white and red plugs of the Component A/V cable to the audio input jack of your TV.

Playing the image on a TV (Continued)

 : Signal flow

Type	Camcorder	Cable	TV	HOME MENU setting
------	-----------	-------	----	-------------------

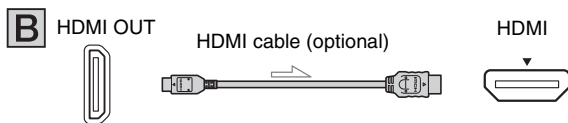

- Use an HDMI cable with the HDMI logo (see the cover).
- Use an HDMI mini connector on one end (for the camcorder), and a connector suitable for connection to your TV on the other end.
- Images are not output from the HDMI OUT jack, if copyright protection signals are recorded in the images.
- Some TVs may not function correctly (e.g., no sound or image) with this connection.
- Do not connect the HDMI OUT jack of your camcorder and HDMI OUT jack of the external device with the HDMI cable. This may cause a malfunction.
- When connected to another device compatible with 5.1ch surround sound using the HDMI cable (optional), the movie recorded with HD (high definition) image quality and the 5.1ch sound is automatically output in the 5.1ch sound. The movie recorded with SD (standard definition) image quality is automatically converted to the 2ch sound and output.

Connecting to a non-high-definition 16:9 (wide) or 4:3 TV

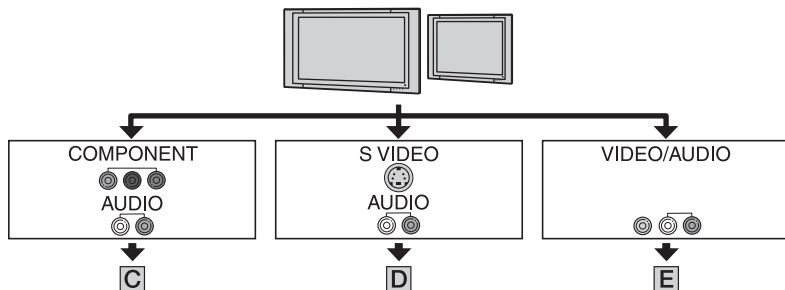

Images recorded with HD (high definition) quality is converted to SD (standard definition) and played back. Images recorded with SD (standard definition) image quality are played back with SD (standard definition) image quality.



To set the aspect ratio according to the connected TV (16:9/4:3)

Set [TV TYPE] to [16:9] or [4:3] according to your TV (p. 95).

Notes

- When you play back a movie recorded with SD (standard definition) image quality on a 4:3 TV that is not compatible with the 16:9 signal, touch  (HOME) →  (SETTINGS) → [MOVIE SETTINGS] → [WIDE SELECT] → [4:3] on your camcorder when recording an image (p. 87).

↗ : Signal flow

Type	Camcorder	Cable	TV	HOME MENU setting
------	-----------	-------	----	-------------------

C

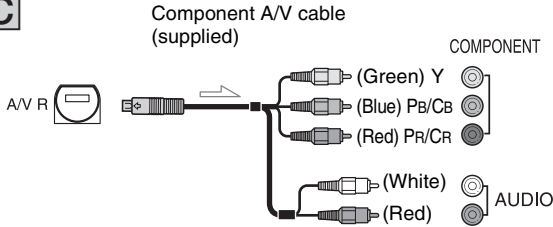

⊞ (SETTINGS) →
[OUTPUT SETTINGS]
→ [COMPONENT] →
[480i] (p. 95)

⊞ (SETTINGS) →
[OUTPUT SETTINGS]
→ [TV TYPE] → [16:9]/
[4:3]* (p. 95)

- When the component plugs are connected, audio signals are not output. To output audio signals, connect the white and red plugs of the Component A/V cable to the audio input jack of your TV.

D

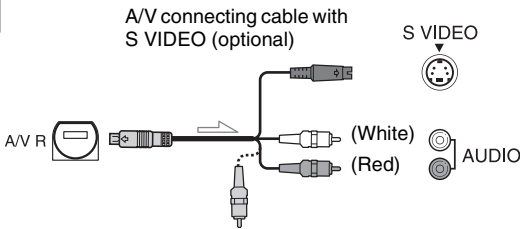

⊞ (SETTINGS) →
[OUTPUT SETTINGS]
→ [TV TYPE] → [16:9]/
[4:3]* (p. 95)

- When the S VIDEO plug (S VIDEO channel) is connected, audio signals are not output. To output audio signals, connect the white and red plugs of an A/V connecting cable with S VIDEO to the audio input jack of your TV.
- This connection produces higher resolution images compared with the A/V connecting cable (Type **E**).

E

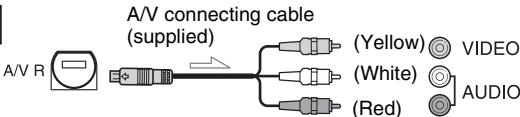

⊞ (SETTINGS) →
[OUTPUT SETTINGS]
→ [TV TYPE] → [16:9]/
[4:3]* (p. 95)

- * Assign an appropriate setting according to the TV used.

Playing the image on a TV (Continued)

When connecting to your TV via a VCR

Connect your camcorder to the LINE IN input on the VCR using the A/V connecting cable. Set the input selector on the VCR to LINE (VIDEO 1, VIDEO 2, etc.).

When your TV is monaural (When your TV has only one audio input jack)

Connect the yellow plug of the A/V connecting cable to the video input jack and connect the white (left channel) or red (right channel) plug to the audio input jack of your TV or VCR.

On “PhotoTV HD”

This camcorder is compatible with the “PhotoTV HD” standard. “PhotoTV HD” allows for highly-detailed, photo-like depiction of subtle textures and colors. By connecting Sony’s PhotoTV HD-compatible devices using an HDMI cable (optional)* or the component A/V cable (supplied)**, a whole new world of photos can be enjoyed in breathtaking full HD quality.

- * The TV will automatically switch to the appropriate mode when displaying photos.
- ** Setup of the TV will be necessary. Please refer to the instruction manual of your PhotoTV HD-compatible TV for details.

⚙ Notes

- When you output images using the A/V connecting cable, images are output with SD (standard definition) image quality.

💡 Tips

- If you connect your camcorder to your TV using more than one type of cable to output images, the order of priority of the output signal is as follows:
HDMI → component video → S VIDEO → audio/video
- HDMI (High Definition Multimedia Interface) is an interface to send both video/audio signals. The HDMI OUT jack outputs high quality images and digital audio.

Using “BRAVIA” Sync

You can do the playback operation with the remote commander of your TV* by connecting your camcorder to a “BRAVIA” Sync compatible TV with the HDMI cable.

* “BRAVIA” TVs sold in 2008 or later are compatible.

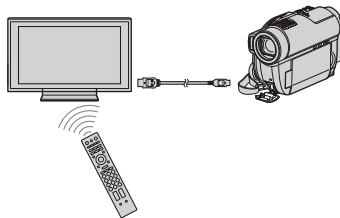



1 Connect your camcorder and a “BRAVIA” Sync compatible TV* with the HDMI cable (optional).

2 Turn on your camcorder.



The TV input is converted automatically, and the image of your camcorder is displayed on the TV.

3 Operate the remote commander of the TV.

You can do the following operations.

- Display  (VIEW IMAGES) of  (HOME) by pressing SYNC MENU button
- Display an INDEX screen such as the VISUAL INDEX screen by pressing up/down/right/left or enter button of the remote commander, and play back the desired movies or still images

Notes

- To set your camcorder, touch  (HOME) →  (SETTINGS) → [GENERAL SET] → [CTRL FOR HDMI] → [ON] (the default setting).
- Your TV also need to be set. Refer to the instruction manual of the TV for details.

Tips

- If you turn off the TV, your camcorder is turned off simultaneously.



(OTHERS) category

This category enables you to edit the images recorded on the media. In addition, this category enables you to utilize your camcorder by connecting it to other devices.



 (OTHERS) category

USB CONNECT

You can connect your camcorder to a computer or other devices using the USB cable (p. 105).

TV CONNECT Guide

Your camcorder helps you select the appropriate connection for your TV (p. 50).

Item list

DELETE

You can delete the images on the media (p. 57).

PHOTO CAPTURE

You can capture a desired scene as a still image from a recorded movie (p. 59).

MOVIE DUB

You can dub movies recorded on the internal memory (HDR-UX20) or the “Memory Stick PRO Duo” to a disc (p. 61).

PHOTO COPY (HDR-UX20)

You can copy still images recorded on the internal memory to a “Memory Stick PRO Duo” (p. 63).

EDIT

You can edit the images on the media (p. 64).

PLAYLIST EDIT

You can create and edit a Playlist (p. 65).

PRINT

You can print still images on a connected PictBridge printer (p. 70).

Deleting images

You can delete the images recorded on the media using your camcorder.

Notes

- You cannot restore images once they are deleted.
- You cannot delete images on the “Memory Stick PRO Duo” when the write-protection is set to the images.

Tips

- You can select up to 100 images at one time.
- You can delete an image on the playback screen using the  (OPTION) menu.

Deleting the movies



Set the media that contains the movie to be deleted in advance (p. 28).

Notes

- During Easy Handycam operation, you cannot delete movies on the disc. Cancel Easy Handycam operation.



1 Touch  (HOME) →  (OTHERS) → [DELETE].

2 Touch  [DELETE].

3 Touch  [HD] DELETE/  [SD] DELETE/  [DELETED].

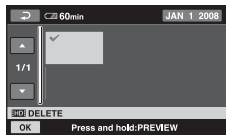
4 Touch the movie to be deleted.







The selected movie is marked with . Press and hold the movie on the LCD screen to confirm. Touch  to return to the previous screen.

5 Touch  [OK] → [YES].

6 When [Completed.] appears, touch  [OK].



To delete all movies at one time







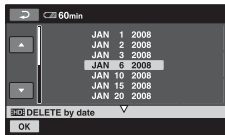

- ① In step 3, touch  [HD] DELETE ALL/  [SD] DELETE ALL/  [DELETED ALL].
- ② Touch [YES] → [YES].
- ③ When [Completed.] appears, touch  [OK].

To delete all the movies recorded on the same day at one time



- ① In step 3, touch  [HD] DELETE by date/  [SD] DELETE by date].



- ② Touch  /  to select the recording date of the desired movies, then touch  [OK].
The movies recorded on the selected date are displayed on the LCD screen. Touch the movie on the LCD screen to confirm. Touch  to return to the previous screen.
- ③ Touch  [OK] → [YES].

Deleting images (Continued)

- ④ When [Completed.] appears, touch **OK**.

To delete the most recently recorded movie



- ① In step 3, touch **[LAST SCENE DEL]**.
- ② Touch **OK** → **[YES]**.
- ③ When [Completed.] appears, touch **OK**.

Notes

- You cannot delete the most recently recorded movie on a disc when performing the following operations after recording:
 - Eject the disc
 - Turn off the camcorder

To delete SD (standard definition) image quality movies

- You can delete movies on DVD-RW (VR mode) discs without any restrictions.
- You can perform only **[LAST SCENE DEL]** on DVD-RW (VIDEO mode) and DVD+RW discs.

Notes

- Do not remove the battery pack or the AC Adaptor from your camcorder while deleting movies.
- Do not eject the “Memory Stick PRO Duo” from your camcorder while deleting the images on the “Memory Stick PRO Duo.”
- If the deleted movie is included in the Playlist (p. 65), the movie is deleted also from the Playlist.
- Even if you delete unnecessary movies from the disc, the remaining disc capacity may not increase as much as you can make additional recording.

Tips

- To delete all images recorded on the media, format the media (p. 78).

Deleting the still images



Set the media that contains the still image to be deleted in advance (p. 29).

-
- 1 Touch **HOME** → **(OTHERS)** → **[DELETE]**.

-
- 2 Touch **[DELETE]**.

-
- 3 Touch **[DELETE]**.

-
- 4 Touch the still image to be deleted.

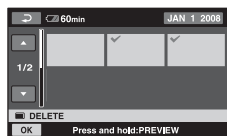

The selected still image is marked with ✓. Press and hold the still image on the LCD screen to confirm. Touch **RETURN** to return to the previous screen.

-
- 5 Touch **OK** → **[YES]**.

-
- 6 When [Completed.] appears, touch **OK**.
-

Capturing a still image from a movie

To delete all still images at one time



- ① In step 3, touch [DELETE ALL].
- ② Touch [YES] → [YES].
- ③ When [Completed.] appears, touch .

To delete all the still images recorded on the same day at one time



- ① In step 3, touch [DELETE by date].

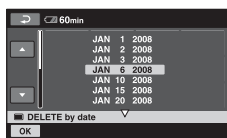

- ② Touch / to select the recording date of the desired still images, then touch . The still images recorded on the selected date are displayed on the screen. Touch the still image on the LCD screen to confirm. Touch to return to the previous screen.
- ③ Touch → [YES].
- ④ When [Completed.] appears, touch .

Tips

- To delete all images recorded on the media, format the media (p. 78).

You can capture a desired scene as a still image from a recorded movie. Set the media which contains movies in advance, and the media where you want to save the still images (p. 28). When you set the media for movies or still images to “Memory Stick PRO Duo,” insert the “Memory Stick PRO Duo” into your camcorder.

The media you can select depends on your camcorder model. See the table below.

Model	Movies in	Still images in
HDR-UX10		→
		→
HDR-UX20		→
		→
		→
		→
		→
		→

Notes

- Using AC Adaptor as the power source is recommended to prevent the power from being turned off during operation.

1 Touch (HOME) → (OTHERS) → [PHOTO CAPTURE].

The [PHOTO CAPTURE] screen appears.

Capturing a still image from a movie (Continued)

2 Touch the movie that you want to capture a still image from.

The selected movie is played back.



3 Touch to pause at the point where you want to capture.

The movie pauses.

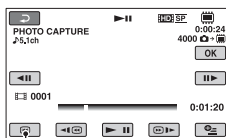

Play and pause toggles as you press





Returns to the beginning of the selected movie.

You can adjust the capturing point with more precision using  / .

4 Touch .

While capturing a still image,  is displayed, then playback for movies is paused when the operation is complete. To capture other still images, touch  and repeat the procedure from step 2.

Notes

- The image size is fixed depending on the image quality or the aspect ratio of movies as follows:
 - HD (high definition) image quality:
 2.1M]
 - SD (standard definition) image quality/16:9:
 0.2M]
 - SD (standard definition) image quality/4:3:
 (0.3M)]
- Still images cannot be recorded unless there is sufficient free space on the media set for still images.









- The recording date and time of the newly captured still image are the same recording date and time of the original movie.
- When you capture a still image from a movie without its recording date and time displayed, the recording date and time of the newly captured still image will be the date and time it was captured.

Dubbing/copying images from one media to another media on your camcorder

Dubbing movies

You can dub movies from the internal memory (HDR-UX20) or a “Memory Stick PRO Duo” to a disc without changing their image quality.



The compatibility of the media types varies depending on the types of your camcorder. For details, see the table below.

Model	From	To
HDR-UX10		→ 
		→ 
HDR-UX20		→ 
		→ 

You cannot dub movies recorded both with HD (high definition) image quality and SD (standard definition) image quality onto one disc. Also, you cannot change the image quality of the disc midway.



Insert the disc into the camcorder in advance. When using a brand new disc, go to “Step 6” (p. 30), and when using a DVD-RW/DVD+RW disc that contains recordings, format the disc (p. 79) first, then match the image quality of movies for dubbing with that of the disc.

Notes

- Connect your camcorder to the wall outlet (wall socket) using the supplied AC Adaptor for this operation.
- When performing [DUB by select], [DUB by date], [] DUB ALL] or [] DUB ALL], if the disc space is not sufficient to record the entire movie, [Not enough memory space.] appears.

Tips

- To check the dubbed movies after dubbing is complete, set [MOVIE MEDIA SET] to [DISC] and play them back (p. 28).

- 1 Touch  (HOME) →  (OTHERS) → [MOVIE DUB], or press DUBBING button (HDR-UX20).

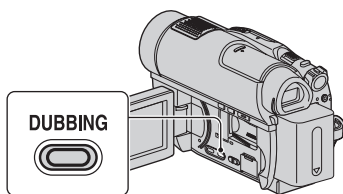

The [MOVIE DUB] screen appears.

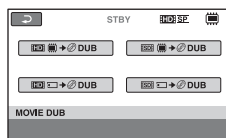

- 2 Select the desired image quality and the media that contains the movie to be dubbed, then touch an appropriate button.

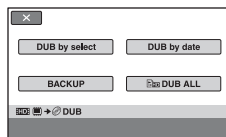

- 3 Touch [DUB by select].

Dubbing/copying images from one media to another media on your camcorder (Continued)

4 Touch the desired movie for dubbing.

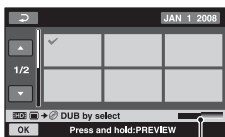

Remaining disc capacity*

- * Displays remaining memory space of disc. Each color displays the following status.
Black: Used memory space
Green: Memory space scheduled to be used
White: Free memory space

The selected movie is marked with ✓. Press and hold the movie on the LCD screen to confirm. Touch [↩] to return to the previous screen.

5 Touch [OK] → [YES].

6 When [Completed.] appears, touch [OK].

To dub all the movies recorded on the same day at one time

- ① In step 3, touch [DUB by date].

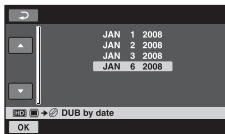

- ② Touch [▲]/[▼] to select the recording date of the desired movies, then touch [OK].

The movies recorded on the selected date are displayed on the screen. Touch the movie on the LCD screen to confirm. Touch [↩] to return to the previous screen.

- ③ Touch [OK] → [YES].
- ④ When [Completed.] appears, touch [OK].

To dub the movies on the Playlist

- ① In step 3, touch [▶HD DUB ALL]/ [▶SD DUB ALL].
- ② Touch [YES].
- ③ When [Completed.] appears, touch [OK].

To back up movies that have not been backed up

- ① In step 3, touch [BACKUP].
- ② Touch [Backs up unbacked up movies.] → [YES].
- ③ When [Completed.] appears, touch [OK]. When the movies for backup cannot be stored onto one disc, the [Disc is full.] message with the estimated number of remaining discs for further recordings will be displayed.

To back up the rest of the movies, provide necessary number of discs, and repeat the procedure from step ①.

⚠ Notes

- If movies are backed up on 2 or more discs, the movie recorded at the end of each disc is divided automatically to fit in the full disc capacity.

💡 Tips

- In step 3, by touching [BACKUP] → [Backup starts from the first movie. Previous backup history will be deleted.], you can back up all movies, including movies that have been backed up previously. Your camcorder will keep a backup history of movies only when they are saved with the [BACKUP] function.

Copying still images (HDR-UX20)

Copy the still images recorded on the internal memory to a “Memory Stick PRO Duo.” Insert the “Memory Stick PRO Duo” into the camcorder in advance.

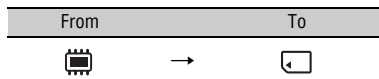

Notes

- Connect your camcorder to the wall outlet (wall socket) using the supplied AC Adaptor for this operation.

Tips

- To check the copied still images after copying is complete, set [PHOTO MEDIA SET] to [MEMORY STICK] and play them back (p. 29).

- 1 Touch **HOME** → **OTHERS** → [PHOTO COPY].

The [PHOTO COPY] screen appears.

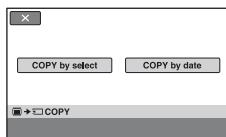

- 2 Touch [COPY by select].

- 3 Touch the desired still image for copying.

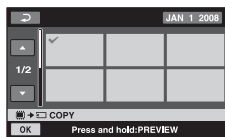

The selected still image is marked with ✓. Press and hold the still image on the LCD screen to confirm. Touch **RETURN** to return to the previous screen.

- 4 Touch **OK** → [YES].

- 5 When [Completed.] appears, touch **OK**.

To copy all the still images recorded on the same day at one time

- 1 In step 2, touch [COPY by date].

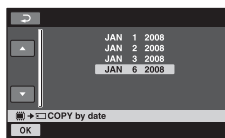

- 2 Touch **UP**/**DOWN** to select the recording date of the desired still images, then touch **OK**.

The still images recorded on the selected date are displayed on the screen. Touch the still image on the LCD screen to confirm. Touch **RETURN** to return to the previous screen.

- 3 Touch **OK** → [YES].
- 4 When [Completed.] appears, touch **OK**.

Dividing movies



Set the media that contains the movie to be divided in advance (p. 28).

1 Touch **HOME** →
OTHERS → **[EDIT]**.

2 Touch **[DIVIDE]**.

3 Touch the movie to be divided.

The selected movie is played back.

4 Touch **[PAUSE]** at the point where you want to divide the movie into the scenes.

The movie pauses.

Play and pause toggles as you press



Returns to the beginning of the selected movie.

You can adjust the capturing point with more precision using **[LEFT ARROW]** / **[RIGHT ARROW]**.

5 Touch **[OK]** → **[YES]**.

6 When **[Completed.]** appears, touch **[OK]**.

Notes

- You cannot restore movies once they are divided.
- Do not remove the battery pack or the AC Adaptor from your camcorder while dividing the movie.
- Do not eject the “Memory Stick PRO Duo” while dividing movies from the “Memory Stick PRO Duo.”
- For the SD (standard definition) image quality, you can divide a movie only with DVD-RW (VR mode).
- When [MOVIE MEDIA SET] is set to the internal memory (HDR-UX20) or the “Memory Stick PRO Duo,” the movies added to the Playlist will be divided after the original movies are also divided.
- When [MOVIE MEDIA SET] is set to the disc, the movies added to the Playlist will not be divided even after the original movies are divided.
- A slight difference may occur from the point where you touch **[PAUSE]** and the actual dividing point, as your camcorder selects the dividing point based on about half-second increments.

Tips

- You can divide a movie on the playback screen by using **[OPTION]** menu.
- The images recorded on your camcorder are called “original.”

Creating the Playlist



A Playlist is a list showing thumbnails of the movies that you have selected. The original movies are not changed, even if you edit or delete the movies in the Playlist. Set the desired media for creating/playback/editing a Playlist in advance (p. 28).

Notes

- Movies with HD (high definition) image quality and SD (standard definition) image quality are added to an individual Playlist.

Tips

- To the Playlist on the internal memory (HDR-UX20) or the “Memory Stick PRO Duo,” you can add a maximum of 999 movies with HD (high definition) image quality, or 99 movies with SD (standard definition) image quality. To the Playlist on the disc, you can add a maximum of 999 movies.
- The images recorded on your camcorder are called “original.”

1 Touch **HOME** → **OTHERS** → **[PLAYLIST EDIT]**.

2 Touch **[H:HD] ADD**/**[S:SD] ADD**/**[#] ADD**.

3 Touch the movie to be added to the Playlist.

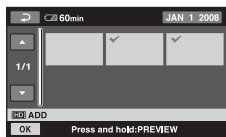

The selected movie is marked with ✓. Press and hold the movie on the LCD screen to confirm. Touch **[RETURN]** to return to the previous screen.

4 Touch **[OK]** → **[YES]**.

5 When **[Completed.]** appears, touch **[OK]**.

To add all the movies to the Playlist



- ① In step 2, touch **[#] ADD ALL**.
- ② Touch **[YES]** → **[YES]**.
- ③ When **[Completed.]** appears, touch **[OK]**.

Notes

- You cannot add all movies recorded on a disc to a Playlist at once, when the movies are recorded with both the “1920 × 1080/60i” standard and the “1440 × 1080/60i” standard on the disc.

To add all the movies recorded on the same day at one time



- ① In step 2, touch **[H:HD] ADD** by date] or **[S:SD] ADD** by date]. The recording dates of movies are displayed on the screen.

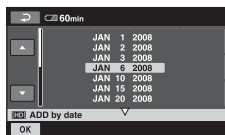

Creating the Playlist (Continued)

- Touch / to select the recording date of the desired movies, then touch .
The movies recorded on the selected date are displayed on the LCD screen. Touch the movie on the LCD screen to confirm. Touch to return to the previous screen.
- Touch → [YES].
- When [Completed.] appears, touch .

Notes

- Do not remove the battery pack or the AC Adaptor from your camcorder while adding a movie to the Playlist.
- Do not eject the “Memory Stick PRO Duo” from your camcorder while adding a movie to the Playlist on the “Memory Stick PRO Duo.”
- You cannot add still images to a Playlist.
- You can create the Playlist only with DVD-RW (VR mode) for the SD (standard definition) image quality.
- To create a Playlist on a disc with HD (high definition) image quality, you cannot contain movies recorded with both the “1920 × 1080/60i” standard and the “1440 × 1080/60i” standard in the Playlist.

Tips

- You can add a movie on the playback screen by using (OPTION) menu.
- You can save the Playlist to a disc on your computer by using the supplied software.

Playing the Playlist



Set the desired media for creating/playback/editing a Playlist in advance (p. 28).

Notes

- For the SD (standard definition) image quality, you can edit a movie only with DVD-RW (VR mode).

- Touch (HOME) → (VIEW IMAGES) → [PLAYLIST].

The Playlist screen appears.



- Touch the movie from which you want to play back.

The Playlist is played back from the selected movie to the end, then the screen returns to the Playlist screen.

To erase unnecessary movies from the Playlist



- Touch (HOME) → (OTHERS) → [PLAYLIST EDIT].
- Touch [ERASE]/[ERASE]/[ERASE].
To erase all the movies from the Playlist, touch [ERASE ALL]/[ERASE ALL]/[ERASE ALL] → [YES] → [YES]. When [Completed.] appears, touch .
- Touch the movie to be erased from the list.



The selected movie is marked with . Press and hold the movie on the LCD screen to confirm. Touch to return to the previous screen.

- ④ Touch **[OK]** → [YES].
- ⑤ When [Completed.] appears, touch **[OK]**.

💡 Tips

- The original movies are not changed even if you erase the movies from the Playlist.

To change the order within the Playlist



- ① Touch **[HOME]** → **[OTHERS]** → **[PLAYLIST EDIT]**.
- ② Touch **[HD MOVE]**/**[SD MOVE]**/**[MOVE]**.
- ③ Touch the movie to be moved.

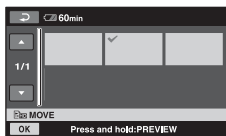

The selected movie is marked with ✓. Press and hold the movie on the LCD screen to confirm. Touch **[RETURN]** to return to the previous screen.

- ④ Touch **[OK]**.
- ⑤ Select the destination with **[LEFT]**/**[RIGHT]**.

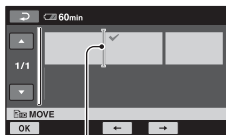

Destination bar

- ⑥ Touch **[OK]** → [YES].
- ⑦ When [Completed.] appears, touch **[OK]**.

💡 Tips

- When you select multiple movies, the movies are moved following the order appeared in the Playlist.

To divide a movie within the Playlist



- ① Touch **[HOME]** → **[OTHERS]** → **[PLAYLIST EDIT]**.
- ② Touch **[DIVIDE]**.
- ③ Touch the movie to be divided. The selected movie is played back.
- ④ Touch **[PAUSE]** at the point where you want to divide the movie into scenes. The movie pauses.



Play and pause toggles as you press



You can adjust the capturing point with more precision using **[LEFT]**/**[RIGHT]**.

- ⑤ Touch **[OK]** → [YES].
- ⑥ When [Completed.] appears, touch **[OK]**.

📌 Notes

- A slight difference may occur from the point where you touch **[PAUSE]** and the actual dividing point, as your camcorder selects the dividing point based on about half-second increments.

💡 Tips

- The original movies are not changed even if you divide the movie in the Playlist.

Dubbing movies to other recording devices

Connecting with the A/V connecting cable

You can dub movies played back on your camcorder to other recording devices, such as VCRs or DVD/HDD recorders. Connect the device in either of the following ways.

Connect your camcorder to the wall outlet (wall socket) using the supplied AC Adaptor for this operation (p. 22). Refer also to the instruction manuals supplied with the devices to be connected.

Notes

- **Movies recorded with HD (high definition) image quality will be dubbed with SD (standard definition) image quality.**
- Since dubbing is performed via analog data transfer, the image quality may deteriorate.
- To dub movies recorded with HD (high definition) image quality, install the application software (supplied) on your computer (p. 105), and copy the images to a disc in the computer.

A/V Remote connector

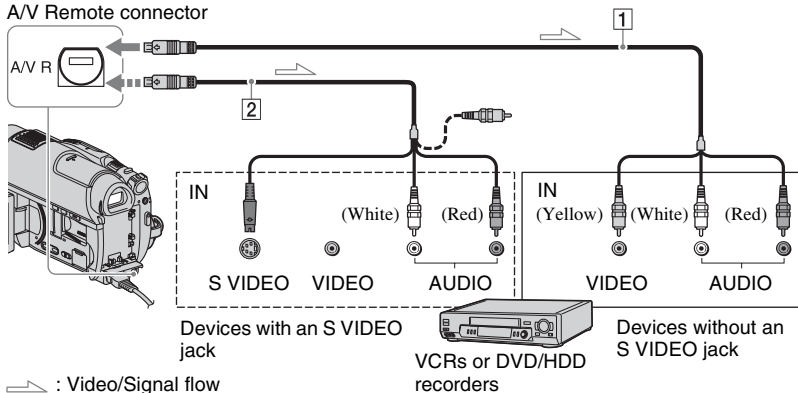

↗ : Video/Signal flow

1 A/V connecting cable (supplied)

Connect to the input jack of the other device.

2 A/V connecting cable with S VIDEO (optional)

When connecting to another device via the S VIDEO jack, by using an A/V connecting cable with an S VIDEO cable (optional), higher quality movies can be produced than with an A/V connecting cable. Connect the white and red plug (left/right audio) and the S VIDEO plug (S VIDEO channel) of the A/V connecting cable with an S VIDEO cable (optional). The yellow plug connection is not necessary. S VIDEO connection only will not output audio.

Notes

- You cannot dub to other recording devices connected with an HDMI cable.
- To hide the screen indicators (such as a counter, etc.) on the screen of the monitor device connected, touch (HOME) → (SETTINGS) → [OUTPUT SETTINGS] → [DISP OUTPUT] → [LCD PANEL] (the default setting) (p. 95).
- To record the date/time and camera settings data, display them on the screen (p. 92).
- When you are connecting your camcorder to a monaural device, connect the yellow plug of the A/V connecting cable to the video input jack, and the red (right channel) or the white (left channel) plug to the audio input jack on the device.

1 Turn on the camcorder, then set the media that contains the desired movies for dubbing (p. 28).

2 Press  (VIEW IMAGES).

Set [TV TYPE] according to the display device (p. 95).

3 Prepare the recording device.

Turn on the recording device. When dubbing movies to the VCR, insert a cassette tape for recording. When dubbing movies to the DVD recorder, insert a disc for recording. If your recording device has an input selector, set it to the input mode.

4 Connect your camcorder to the recording device (VCR or DVD/HDD recorder) with the A/V connecting cable (supplied) **1** or an A/V connecting cable with S VIDEO (optional) **2**.

Connect your camcorder to the input jacks of the recording device.

5 Start the playback on your camcorder, and record it on the recording device.

Refer to the instruction manuals supplied with your recording device for details.

6 When dubbing is finished, stop the recording device, and then your camcorder.

Connecting with the USB cable

By connecting a DVD writer supporting movie dubbing, etc. to the camcorder via USB connection, you can dub movies with HD (high definition) image quality on the internal memory (HDR-UX20) or a "Memory Stick PRO Duo" without the declination of their image quality. Connect your camcorder to the wall outlet (wall socket) using the supplied AC Adaptor for this operation (p. 22). Refer also to the instruction manuals supplied with the devices to be connected.

Notes

- You cannot dub movies recorded on a disc via USB connection.

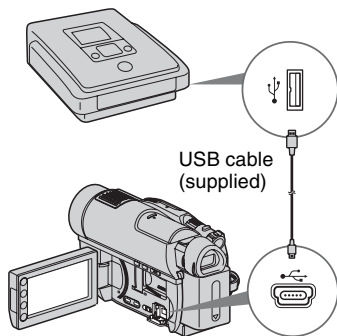

1 Turn on your camcorder.

2 Connect the  (USB) jack of your camcorder to a DVD writer, etc. using the supplied USB cable (p. 140).

The [USB SELECT] screen appears on the screen.

Dubbing movies to other recording devices (Continued)

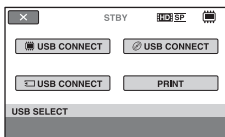



3 Touch the media which contains the movie to be dubbed.

4 Start recording on the connected device.

Refer to the instruction manuals supplied with the connected device for details.

5 When dubbing is finished, touch [END] → [YES] and disconnect the USB cable.

💡 Tips

- If the [USB SELECT] screen does not appear, touch  (HOME) →  (OTHERS) → [USB CONNECT].

Printing recorded still images (PictBridge compliant printer)



You can print out still images using a PictBridge compliant printer, without connecting the camcorder to a computer.

PictBridge

Connect your camcorder to the AC Adaptor to obtain power from the wall outlet (wall socket) (p. 22).

Set the media that contains the still images to be printed in advance (p. 29), then turn on the printer.

To print still images on a “Memory Stick PRO Duo,” insert the “Memory Stick PRO Duo” containing them into your camcorder.

1 Turn on your camcorder.

2 Connect the  (USB) jack of your camcorder to the printer using the supplied USB cable (p. 140).

The [USB SELECT] screen appears on the screen.

3 Touch [PRINT].

When connection is complete,  (PictBridge connecting) appears on the screen.

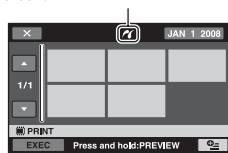

4 Touch the still image to be printed.

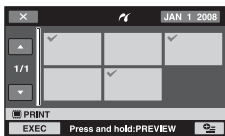

The selected still image is marked with ✓. Press and hold the still image on the LCD screen to confirm. Touch to return to the image selection screen.

5 Touch (OPTION), set the following options, then touch .

[COPIES]: Set number of copies of a still image to be printed. You can set up to 20 copies.

[DATE/TIME]: Select [DATE], [DAY&TIME], or [OFF] (no date/time printed).

[SIZE]: Select the paper size.

If you do not change the setting, go to step 6.

6 Touch [EXEC] → [YES] → .

The still image selection screen appears again.

To finish printing

Touch on the image selection screen.

Notes

- We can guarantee the operation of only models that are PictBridge compatible.
- Refer also to the instruction manual of the printer to be used.

- Do not attempt the following operations when is on the screen. The operations may not be performed properly.
 - Operate the POWER switch.
 - Press (VIEW IMAGES)
 - Disconnect the USB cable from your camcorder or the printer.
 - Eject the “Memory Stick PRO Duo” from your camcorder, while printing the still image on the “Memory Stick PRO Duo.”
- If the printer stops working, disconnect the USB cable, turn the printer off and on again, and restart the operation from the beginning.
- You can select only the paper sizes that the printer can print.
- On some printer models, the top, bottom, right, and left edges of still images may be trimmed. If you print a still image recorded in a 16:9 (wide) ratio, the left and right ends of the image may be trimmed widely.
- Some printer models may not support the date printing function. Refer to your printer’s instruction manual for details.
- The still images described below may not be printed out:
 - The still image edited by a computer
 - The still image recorded by other devices
 - The still image file exceeding 4 MB
 - The still image file larger than 3680 × 2760 pixels

Tips

- PictBridge is an industry standard established by the Camera & Imaging Products Association (CIPA). You can print still images without using a computer by connecting a printer directly to a digital video camera or digital still camera, regardless of model or manufacturer.
- You can print a still image on the playback screen using the (OPTION) menu.

(MANAGE MEDIA) category

This category enables you to use the media for various purposes.



 (MANAGE MEDIA) category

REPAIR IMG.DB F.

You can repair the management information in the internal memory (HDR-UX20) or the “Memory Stick PRO Duo” (p. 82).

Item list

MOVIE MEDIA SET

Set the media for movies (p. 28).

PHOTO MEDIA SET (HDR-UX20)

Set the media for still images (p. 29).

FINALIZE

You can enable discs to be played on other devices by finalizing them (p. 73).

MEDIA INFO

You can display the information about the media such as available recording time (p. 78).

MEDIA FORMAT

You can format the media and recover the recordable free space (p. 78).

UNFINALIZE

You can unfinalize a disc and record more images on it (p. 80).

DISC SELECT GUIDE

Your camcorder advises you of the right disc for your purpose (p. 81).

Making the disc compatible with playback on other devices (Finalizing)

Finalizing makes the recorded disc compatible for playback with other devices and DVD drives of computers.

Before finalizing, you can select a type of DVD menu that enables you to select a particular scene (p. 75).

Discs recorded with HD (high definition) image quality

Discs of all kinds should be finalized.

Discs recorded with SD (standard definition) image quality

- Finalize DVD-R/DVD+R DL/DVD-RW.
- Finalize DVD+RW in the following cases:
 - To create the DVD menu
 - To playback in the DVD drives of computers
 - Recorded time is short (5 minutes or less in HQ mode, 8 minutes or less in SP mode and 15 minutes or less in LP mode)

Notes

- Playback compatibility with all device is not guaranteed.
- Only the devices compatible with the AVCHD format can play the discs recorded with HD (high definition) image quality (p. 76). Currently available DVD devices cannot play these discs.
- In the case of SD (standard definition) image quality, a DVD menu is created instead of a disc menu.

Operation flow

The following operations are for the discs recorded with HD (high definition) image quality.

To play back a disc on another device for the first time (p. 75)

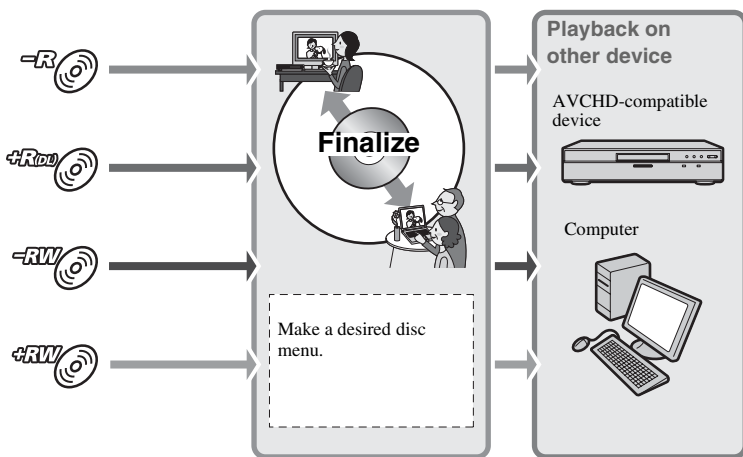

Making the disc compatible with playback on other devices (Finalizing) (Continued)

To add recordings to a finalized disc (p. 80)

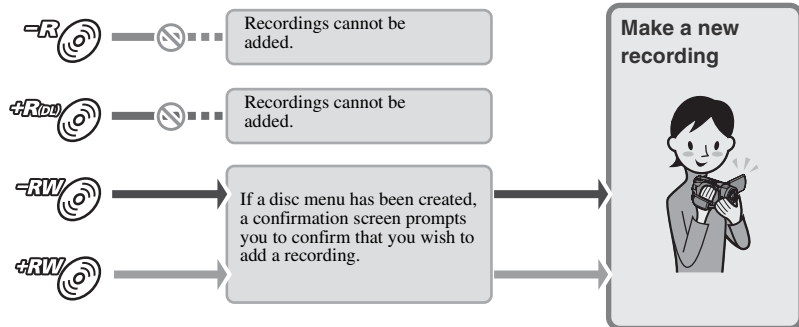

Notes

- During Easy Handycam operation, you cannot add recordings to a finalized disc even if you use DVD-RW or DVD+RW. To do so, cancel Easy Handycam operation (p. 37).

To play back a disc on another device after adding a recording (p. 75)

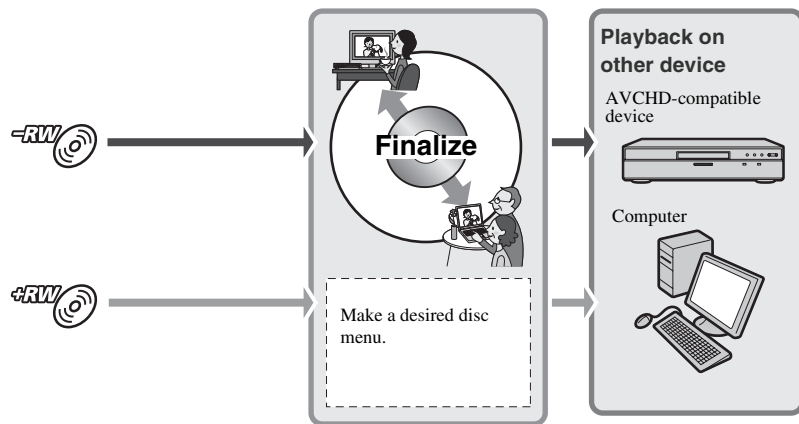

Finalizing a disc

Notes

- It takes from a minute to a maximum of several hours to finalize a disc. The shorter the amount of material recorded on the disc, the longer it takes for finalizing.

1 Place your camcorder in a stable position, then connect the AC Adaptor to the DC IN jack on your camcorder and the wall outlet (wall socket).

2 Turn on your camcorder.

3 Insert the disc to be finalized.

4 Touch  (HOME) →  (MANAGE MEDIA) → [FINALIZE].

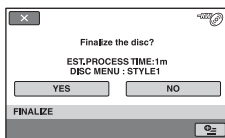



To select a disc menu style, touch  (OPTION) → [DISC MENU].

If you do not change the setting of the disc menu style, go to step 5. The disc menu style is set to [STYLE1] (the default setting).

5 Touch [YES] → [YES] → .



Notes

- When you finalize a double-sided disc, you must finalize each side of the disc individually.
- Do not apply shock or vibration to your camcorder, and do not disconnect the AC Adaptor during finalizing.



When you need to disconnect the AC Adaptor, make sure that the power of your camcorder is set to off and disconnect the AC Adaptor after the  (Movie) or  (Still) lamp goes off. Finalizing restarts when you connect the AC Adaptor and turn on your camcorder again.

- When finalizing the following discs,  flashes after finalizing is completed. Remove the disc from your camcorder.
 - Discs recorded with HD (high definition) image quality
 - Discs recorded with SD (standard definition) image quality, except DVD-RW (VR mode)

Tips

- When you set to create a disc menu (or DVD menu) and finalize the disc, the disc menu appears for a few seconds while finalizing the disc.
- After the disc is finalized, “” is attached at the bottom of the indicator, such as “” in the case of DVD-RW.

To select a disc menu style

- In step 4, touch  (OPTION) → [DISC MENU].
- Select the desired style from 4 types of pattern with  / .

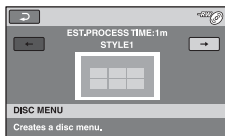

Select [NO MENU] if you do not create a disc menu.

- Touch .

Notes

- During Easy Handycam operation, the disc menu is fixed to [STYLE1].

Making the disc compatible with playback on other devices (Finalizing) (Continued)

- You cannot create the disc menu with DVD-RW (VR mode) for the SD (standard definition) image quality.

Playing a disc on other devices

On the other devices

The kind of device you can play a disc on depends on the image quality (HD (high definition) or SD (standard definition)) selected when the disc was recorded. For details, refer to the instruction manual supplied with your device or consult your dealer.

Discs recorded with HD (high definition) image quality

This camcorder captures high definition footage in the AVCHD format. DVD media containing AVCHD footage should not be used with DVD based players or recorders, as the DVD player/recorder may fail to eject the media and may erase its contents without warning. DVD media containing AVCHD footage may be played on a compatible Blu-ray Disc™ player/recorder or other compatible device.

Discs recorded with SD (standard definition) image quality

You can play these discs back on DVD devices. However, we do not guarantee playback on all DVD devices.

Notes

- Make sure that you finalize a recorded disc (p. 75). However, when you record movies with SD (standard definition) image quality on a DVD+RW disc, you can play the disc without finalizing it (p. 73).
- Do not use an 8 cm CD adaptor with an 8 cm DVD as it may cause a malfunction.
- Make sure that a vertically installed device is placed in a position such as that the disc can be placed horizontally.
- If you have inserted a disc recorded in the AVCHD format in a DVD device, there is a risk that you can neither record nor play back the disc correctly on your camcorder.
- Some discs cannot be played back, may freeze for an instant between scenes. Some functions may be disabled on some devices.

Tips

- Devices that support subtitles can display the recording date and time where the subtitles normally appear (p. 88). Refer to the instruction manual of your device.
- If you have created the disc menu (p. 75), you can select the desired scene in the menu.
- You can also play the playlist back on other devices if the discs were recorded with HD (high definition) image quality (p. 65). Create the playlist on your camcorder in advance, then select  on the disc menu.

On the computer

To play a disc recorded with HD (high definition) image quality

Install “Picture Motion Browser” on the supplied CD-ROM on the computer to play movies (p. 105).

To play a disc recorded with SD (standard definition) image quality

You can play a disc on a computer if a DVD playback application is installed on the computer.

Notes

- Even when you use DVD+RW, you must finalize the disc (p. 73). Otherwise, a malfunction may occur.
- Make sure that the DVD drive of the computer can play an 8 cm DVD.
- Do not use an 8 cm CD adaptor with an 8 cm DVD as it may cause a malfunction.
- The disc may not be played back, or the movies may not be played smoothly on some computers.
- You cannot copy movies directly to the hard disk of your computer to play back or edit them on your computer.

Tips

- For details on operations and procedures, see the “PMB Guide” on the supplied CD-ROM (p. 105).

The volume label of the disc recorded with SD (standard definition) image quality

The date when the disc was first used is recorded.

<e.g.>

When the disc was first used at 6:00 pm on January 1st 2008:

2008_01_01_06H00M_PM

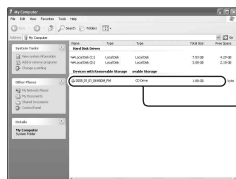

Volume label



Tips

- Movies in discs recorded with SD (standard definition) image quality are stored in the following folders:
 - DVD-RW (VR mode)
DVD_RTAV folder
 - Other discs and modes
VIDEO_TS folder

Checking the media information

You can check the estimated available recording time and memory usage of the media, according to the setting of [MOVIE MEDIA SET] (p. 28).

Touch  (HOME) →  (MANAGE MEDIA) → [MEDIA INFO].

You can check other information by touching . To turn off the display, touch .

Notes

- The calculation for the space of the internal memory (HDR-UX20) or the “Memory Stick PRO Duo” is 1MB = 1,048,576 bytes. The fractions less than MB are discarded when the space is displayed. The displayed size of the whole space will be slightly smaller than the size shown below despite displaying both free and used space.
- Since there is a management file area, the used space is not displayed as 0 MB even if you perform [MEDIA FORMAT] (p. 78).

Tips

- Any media information other than the information set with [MOVIE MEDIA SET] is not displayed. To check other media information, set the other media on [MOVIE MEDIA SET] (p. 28).

Formatting the media

Format means to delete all recorded images from a media to gain the original memory capacity of the media.



Before performing [MEDIA FORMAT], you should save important images on other device or media (p. 61, 68, 105).

Formatting the internal memory (HDR-UX20) or the “Memory Stick PRO Duo”

1 Connect the AC Adaptor to the DC IN jack on your camcorder and the wall outlet (wall socket).

2 Turn on your camcorder.

3 Insert the “Memory Stick PRO Duo” into your camcorder if you perform formatting the “Memory Stick PRO Duo.”

4 Touch  (HOME) →  (MANAGE MEDIA) → [MEDIA FORMAT] → [INT. MEMORY] (HDR-UX20) or [MEMORY STICK].

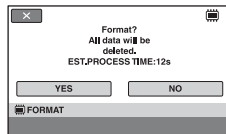

5 Touch [YES] → [YES].

6 When [Completed.] appears, touch .



Notes

- Do not apply shock or vibration to your camcorder, and do not disconnect the AC Adaptor during formatting.
- Even the images protected with another device against accidental deletion are also deleted.
- Do not attempt the following operations when [Executing...] is on the screen:
 - Operate the POWER switch or buttons
 - Eject the “Memory Stick PRO Duo” while formatting the “Memory Stick PRO Duo”



Formatting the disc

A DVD-R/DVD+R DL cannot be formatted. Replace it with a new disc.

If you format a finalized disc

Formatting deletes all movies on a finalized disc. One of the following icons,  or , appears on the screen, but there is no need to finalize the disc again before playing the disc on an AVCHD format compatible player.*

When formatting a disc of the SD (standard definition) image quality



- In the case of a DVD-RW (VIDEO mode), the disc is unfinalized and it has to be finalized again to enable the disc to be played on another device.
- In the case of a DVD-RW (VR mode)/DVD+RW, formatting deletes all images on a finalized disc. One of the following icons,  or , appears on the screen, but there is no need to finalize the disc again before playing the disc on other devices.*

* To create a disc menu (DVD menu) on a DVD+RW or DVD-RW with HD (high definition) image quality, finalize the disc again (p. 73).

1 Connect the AC Adaptor to the DC IN jack on your camcorder and the wall outlet (wall socket).

2 Turn on your camcorder.

3 Insert the disc to be formatted into your camcorder.

4 Touch  (HOME) →  (MANAGE MEDIA) → [MEDIA FORMAT] → [DISC].

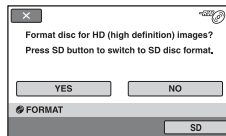

Notes

- The screen message will be different if the disc was formatted with SD (standard definition) image quality at the previous formatting. Follow the procedures on the screen.

5 Touch [YES].

To record with SD (standard definition) image quality, touch [SD].

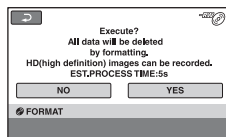

Notes

- You cannot change the image quality of a disc during recording.
- For details on AVCHD format/DVD format, see page 16, 128.

6 Touch the option that is right for you on the screen.

The disc will be formatted in the recording image quality and format you selected.

When formatting is completed, you can start recording on the disc.

To format a disc with SD (standard definition) image quality

- Select the recording format, VIDEO mode or VR mode, for DVD-RW (p. 16). If you format DVD-RW during Easy Handycam operation (p. 34), the recording format is fixed to VIDEO.
- Select the aspect ratio, [16:9 WIDE] or [4:3], for DVD+RW.

Notes

- Do not apply shock or vibration to your camcorder, and do not disconnect the AC Adaptor during formatting.
- When you use a double-sided disc, formatting is required on each side. You can format each side in the different image quality (HD (high definition) or SD (standard definition)).
- In the case of DVD+RW with SD (standard definition) image quality, you cannot change the movie aspect ratio midway. Format the disc again to change the aspect ratio.
- Discs recorded with HD (high definition) image quality can be formatted on AVCHD format compatible devices only (p. 128).
- You cannot format a disc that has been protected on other devices. Cancel the protection with the original device, and then format it.

Recording additional movies after finalizing

You can record additional movies on the finalized DVD-RW/DVD+RW after the following steps.

Additional movies cannot be recorded on a DVD-R/DVD+R DL after finalizing. Replace it with a new disc.

1 Connect the AC Adaptor to the DC IN jack on your camcorder and the wall outlet (wall socket).

2 Slide the POWER switch to turn on the  (Movie) lamp.

3 Insert the finalized disc into your camcorder.

A confirmation screen appears to prompt you to confirm that you wish to record additional movies.

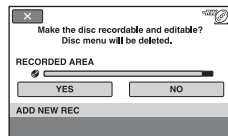



4 Touch [YES] → [YES].

5 When [Completed.] appears, touch .

Finding the right disc (DISC SELECT GUIDE)



Select the option that is right for you on the screen, then you will be informed of the appropriate disc for your purposes.

For the discs recorded with SD (standard definition) image quality

- When using finalized DVD-RW (VR mode) discs, you can record additional material on the disc without any additional steps.
- To unfinalize DVD-RW (VIDEO mode), touch  (HOME) →  (MANAGE MEDIA) → [UNFINALIZE].
- If you have created the DVD menu (p. 75) when finalizing the DVD+RW, the dialog appears to confirm that you wish to record additional movies when you slide the POWER switch and turn on the  (Movie) lamp.

Notes

- Do not apply shock or vibration to your camcorder, and do not disconnect the AC Adaptor during the operation.
- The disc menu created with finalizing are deleted.
- When you use a double-sided disc, perform this operation on each side.

1 Touch  (HOME) →  (MANAGE MEDIA) → [DISC SELECT GUIDE].

2 Touch the option that is right for you on the screen.

When you insert the same type of disc as that indicated in the results of the guide, the disc is formatted with the options you selected (p. 79).

Repairing the image database file



This function checks the management information and the consistency of movies and still images on the internal memory (HDR-UX20), or of movies on the “Memory Stick PRO Duo” and repairs any inconsistencies found.

- 1 Touch **HOME** → **MANAGE MEDIA** → **[REPAIR IMG.DB F.]** → **[INT. MEMORY] (HDR-UX20)** or **[MEMORY STICK]**.

The **[REPAIR IMG.DB F.]** screen appears.

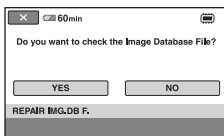

- 2 Touch **[YES]**.

Checking the image database file starts. Touch **[OK]** to finish checking the image database file if no inconsistency is found.

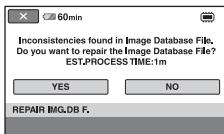

- 3 Touch **[YES]**.

- 4 When **[Completed.]** appears, touch **[OK]**.

Notes

- Do not apply mechanical shock or vibration to your camcorder during repairing the image database file.
- Do not disconnect the AC Adaptor or remove the battery pack during repairing the image database file.
- Do not eject the “Memory Stick PRO Duo” during repairing the image database file on the “Memory Stick PRO Duo.”
- The repairing each image database file in both the internal memory (HDR-UX20) and the “Memory Stick PRO Duo” is performed separately.

Preventing data on the internal memory of the camcorder from being recovered (HDR-UX20)

[EMPTY] allows you to write unintelligible data onto the internal memory of the camcorder. In this way, it may become more difficult to recover any original data.

When you dispose of or transfer the camcorder to others, it is recommended that you perform [EMPTY].

🔔 Notes

- If you perform [EMPTY], all the images on the internal memory are deleted. To avoid the loss of important images, they should be saved on other device or other media before performing [EMPTY] (p. 61, 63, 105).
- You cannot perform [EMPTY] unless you connect the AC Adaptor to the wall outlet (wall socket).
- Disconnect all cables except the AC Adaptor.
- While performing [EMPTY], do not apply any vibrations or shocks to your camcorder.

1 Connect the AC Adaptor to the DC IN jack on your camcorder and the wall outlet (wall socket).

2 Turn on your camcorder.

3 Touch (HOME) → (MANAGE MEDIA) → [MEDIA FORMAT] → [INT. MEMORY].

The confirmation screen of the formatting the internal memory appears.

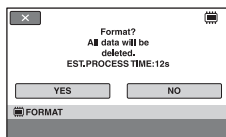

4 Press and hold (back light) (p. 141).

The [EMPTY] screen appears.

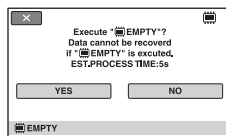

5 Touch [YES] → [YES].

6 When [Completed.] appears, touch [OK].

🔔 Notes

- If you stop performing [EMPTY] while [Executing...] appears, be sure to complete the operation by performing [EMPTY] when you use the camcorder next time.

What you can do with the (SETTINGS) category of the HOME MENU

You can change the recording functions and the operating settings for your convenience.

Using the HOME MENU

- 1 Turn on your camcorder, then press  (HOME).

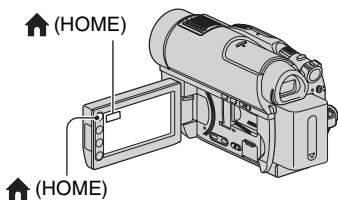



 (SETTINGS) category

- 2 Touch  (SETTINGS).



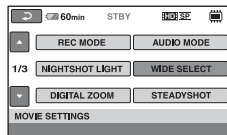

- 3 Touch the desired setup item.

If the item is not on the screen, touch / to change the page.



- 4 Touch the desired item.

If the item is not on the screen, touch / to change the page.

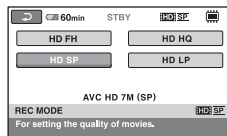

- 5 Change the setting, then touch .

List of the (SETTINGS) category items

MOVIE SETTINGS (p. 86)

Items	Page
REC MODE	86
AUDIO MODE	86
NIGHTSHOT LIGHT	86
WIDE SELECT	87
DIGITAL ZOOM	87
STEADYSHOT	87
AUTO SLW SHUTTR	87
X.V.COLOR	87





Items	Page
GUIDEFAME	88
ZEBRA	88
 REMAINING SET	88
SUB-T DATE	88
FLASH MODE*	88
FLASH LEVEL	89
REDEYE REDUC	89
FACE DETECTION	89
 INDEX SET*	89
CONVERSION LENS	90

PHOTO SETTINGS (p. 90)

Items	Page
 IMAGE SIZE*	90
FILE NO.	91
NIGHTSHOT LIGHT	86
STEADYSHOT	87
GUIDEFAME	88
ZEBRA	88
FLASH MODE*	88
FLASH LEVEL	89
REDEYE REDUC	89
FACE DETECTION	89
CONVERSION LENS	90

VIEW IMAGES SET (p. 92)

Items	Page
DATA CODE	92
 DISPLAY	93

SOUND/DISP SET** (p. 93)

Items	Page
VOLUME*	93
BEEP*	93
LCD BRIGHT	93
LCD BL LEVEL	94

Items	Page
LCD COLOR	94
VF B.LIGHT	94

OUTPUT SETTINGS (p. 95)

Items	Page
TV TYPE	95
DISP OUTPUT	95
COMPONENT	95

CLOCK/ LANG (p. 96)

Items	Page
CLOCK SET*	25
AREA SET	96
DST SET/SUMMERTIME	96
 LANGUAGE SET*	96

GENERAL SET (p. 96)

Items	Page
DEMO MODE	96
REC LAMP	96
CALIBRATION	132
A.SHUT OFF	97
QUICK ON STBY	97
REMOTE CTRL	97
CTRL FOR HDMI	97

* You can set these items also during Easy Handycam operation (p. 34).

** [SOUND SETTINGS] during Easy Handycam operation.

MOVIE SETTINGS

(Items for recording movies)



Touch ①, then ②.

If the item is not on the screen, touch / to change the page.

How to set

(HOME MENU) → page 84

(OPTION MENU) → page 98

The default settings are marked with .

REC MODE



You can select a recording quality to record a movie.

■ For HD (high definition) image quality:

HD FH* (

Records in the highest quality mode.
(AVC HD 16M (FH))

HD FS** (

Records in the highest quality mode.
(AVC HD 14M (FS))

HD HQ (

Records in high quality mode.
(AVC HD 9M (HQ))

▶ HD SP (

Records in standard quality mode.
(AVC HD 7M (SP))

HD LP (

Increases the recording time (Long Play).
(AVC HD 5M (LP))

* For the internal memory (HDR-UX20) or the “Memory Stick PRO Duo” only.

** For the disc only.

■ For SD (standard definition) image quality:

SD HQ (

Records in high quality mode.
(SD 9M (HQ)).

▶ SD SP (

Records in standard quality mode.
(SD 6M (SP)).

SD LP (

Increases the recording time (Long Play).
(SD 3M (LP))

Notes

- If you record in the LP mode, details in movies with quick movements may appear rough when you play back.

Tips

- See page 17, 33 on the expected recording time of each recording mode.
- You can set the recording mode for each media (p. 28).

AUDIO MODE



You can select the sound recording mode.

▶ 5.1ch SURROUND ()

Records sound in 5.1ch surround.

2ch STEREO ()

Records sound in 2ch stereo.

NIGHTSHOT LIGHT



When using either the NightShot (p. 41) or [SUPER NIGHTSHOT] (p. 103) function to record, you can record clearer images by setting [NIGHTSHOT LIGHT], which emits infrared light (invisible), to [ON] (the default setting).

Notes

- Do not cover the infrared port with your fingers or other objects (p. 41).
- Remove the conversion lens (optional).

- The maximum shooting distance using [NIGHTSHOT LIGHT] is about 3 m (10 feet).

WIDE SELECT

When recording with SD (standard definition) image quality, you can select the aspect ratio according to the TV connected. Refer also to the instruction manuals supplied with your TV.

► 16:9 WIDE

Records images to the full screen on a 16:9 (wide) TV screen.

4:3

Records images to the full screen on a 4:3 TV screen.

Notes

- Set [TV TYPE] correctly according to the TV connected for playback (p. 95).

DIGITAL ZOOM

You can select the maximum zoom level in case you want to zoom to a level greater than 15 × (optical zoom) during recording. Note that the image quality decreases when you use the digital zoom.

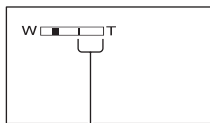

The right side of the bar shows the digital zooming factor. The zooming zone appears when you select the zooming level.

► OFF

Up to 15 × zoom is performed optically.

30 ×

Up to 15 × zoom is performed optically, and after that, up to 30 × zoom is performed digitally.

180 ×

Up to 15 × zoom is performed optically, and after that, up to 180 × zoom is performed digitally.

STEADYSHOT

You can compensate for camera shake. Set [STEADYSHOT] to [OFF] () when using a tripod (optional), then the image becomes natural. The default setting is [ON].

AUTO SLW SHUTTR (Auto Slow Shutter)

The shutter speed becomes 1/30 seconds automatically when shooting in dark places. The default setting is [ON].

X.V.COLOR

When recording, set to [ON] to capture wider range of colors. Various colors such as the brilliant color of flowers and turquoise blue of the sea can be more faithfully reproduced.

Notes

- Set [X.V.COLOR] to [ON] only when the recorded content will be played back on an x.v.Color-compliant TV. Otherwise, set to [OFF] (the default setting).
- If the movies recorded with this function [ON] is played back on a non-x.v.Color-compliant TV, the color may not be reproduced correctly.
- [X.V.COLOR] cannot be set to [ON]:
 - when the disc is not formatted with HD (high definition) image quality.
 - when recording a movie with SD (standard definition) image quality on the internal memory (HDR-UX20) or the “Memory Stick PRO Duo.”
 - while recording a movie.

MOVIE SETTINGS (Continued)

GUIDEFAME

You can display the guide frame and check that the subject is horizontal or vertical by setting [GUIDEFAME] to [ON].

The guide frame is not recorded. Press DISP/BATT INFO to make the guide frame disappear. The default setting is [OFF].

Tips

- Positioning the subject at the cross point of the guide frame makes a balanced composition.

ZEBRA

Diagonal stripes appear in portions of the screen where brightness is at a preset level. This is useful as a guide when adjusting the brightness. When you change the default setting,  is displayed. The zebra pattern is not recorded.

▶ OFF

The zebra pattern is not displayed.

70

The zebra pattern appears at a screen brightness level of about 70 IRE.

100

The zebra pattern appears at a screen brightness level of about 100 IRE or higher.

Notes

- Portions of the screen where brightness is about 100 IRE or above may appear overexposed.

Tips

- IRE represents the screen brightness level.



REMAINING SET

▶ ON

Always displays the remaining media indicator.

AUTO

Displays the remaining recording time of movies for about 8 seconds in situations such as those described below.

- When your camcorder recognizes the remaining media capacity with the  (Movie) lamp lighting up.
- When you press DISP/BATT INFO to switch the indicator from off to on with the  (Movie) lamp lighting up.
- When you select the movie recording mode on the HOME MENU.



Notes

- When the remaining recordable time for movies is less than 5 minutes, the indicator stays on the screen.

SUB-T DATE

You can display the recording date and time when you play back images on a device with a subtitle display function. The default setting is [ON]. Also refer to the instruction manual of the playback device.

Notes

- Discs recorded with HD (high definition) image quality or the “Memory Stick PRO Duo” can be played on AVCHD format compatible devices only (p. 76).
- When [MOVIE MEDIA SET] is set to  INT. MEMORY] (HDR-UX20) or  MEMORY STICK], you cannot use this function.

FLASH MODE

You can set this function when you shoot still images using the built-in flash, or an external flash (optional) that is compatible with your camcorder.

▶ AUTO

Automatically flashes when there is insufficient ambient light.

ON (⚡)

Always flashes regardless of the surrounding brightness.

OFF (🚫)

Records without flash.

🔌 Notes

- The recommended distance to the subject when using the built-in flash is approximately 0.3 to 2.5 m (1 to 8 feet).
- Remove any dust from the surface of the flash lamp before using it. Flash effect may be impaired if heat discoloration or dust obscures the lamp.
- ⚡/CHG lamp (p. 139) flickers while charging the flash, and remains lit when charging is complete.
- If you use the flash when shooting a backlit subject or in bright places, the flash may not be effective.

FLASH LEVEL

You can set this function when you shoot still images using the built-in flash, or an external flash (optional) that is compatible with your camcorder.

HIGH(++)

Makes the flash level higher.

▶ NORMAL(±)

LOW(+-)

Makes the flash level lower.

REDEYE REDUC

You can set this function when you shoot still images using the built-in flash, or an external flash (optional) that is compatible with your camcorder.

Set [REDEYE REDUC] to [ON], then set [FLASH MODE] (p. 88) to [AUTO] or [ON] to display 📷.

You can prevent redden by activating the flash before recording.

🔌 Notes

- The redden reduction may not produce the desired effect due to individual differences and other conditions.

FACE DETECTION

Adjusts the focus/color/exposure of face images automatically. Also, adjusts face images for clear viewing.

▶ ON (👤)

Detects face images in frames, then adjusts their image quality automatically.

Face detection frame

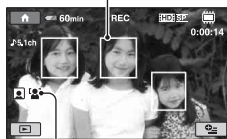

Face detection icon

ON [NO FRAMES] (👤)

Detects face images without frames, then adjusts their image quality automatically.

OFF

Face images are no detected.

🔌 Notes

- Your camcorder may not be able to detect face images depending on the recording condition.
- Your camcorder may not be able to optimize the images depending on the recording condition. In this case, set [FACE DETECTION] to [OFF].

INDEX SET

The camcorder detects faces automatically during movie recording. The default setting is [ON].

Face icons and their meanings

- 👤 : This icon appears when the setting is [ON].
- 👤 : This icon flashes when your camcorder detects a face. The icon stops flashing when the face is recorded in the Face Index.
- 🚫👤 : This icon appears when faces cannot be recorded in the Face Index.

MOVIE SETTINGS (Continued)

To play back a movie from the Face Index screen, see page 47.

Notes

- The detectable number of face image is limited.

CONVERSION LENS



You can set this function when you use an external conversion lens (optional) that is compatible with your camcorder. You can shoot with the SteadyShot function adjusted optimally for the conversion lens attached. You can select from [WIDE CONVERSION] (W) and [TELE CONVERSION] (T). The default setting is [OFF].

PHOTO SETTINGS

(Items for recording still images)



Touch ①, then ②.

If the item is not on the screen, touch / to change the page.

How to set

- (HOME MENU) → page 84
- (OPTION MENU) → page 98

The default settings are marked with ►.

IMAGE SIZE



► 4.0M (4.0M 2304 × 1728)

Records still images clearly in the 4:3 ratio.

16:9 3.0M (3.0M 2304 × 1296)

Records still images clearly in the 16:9 (wide) ratio.

1.9M (1.9M 1600 × 1200)

Allows you to record more still images in relatively clear quality in the 4:3 ratio.

VGA (0.3M) (VGA 640 × 480)

Allows the maximum number of still images to be recorded in the 4:3 ratio.

Notes

- The set image size is effective during the (Still) lamp turning on.

The number of still images recordable on the internal memory (HDR-UX20)

The maximum number of recordable still images is 9,999. The number of recordable still images varies depending on the recording conditions.

Capacity of a “Memory Stick PRO Duo” and the number of recordable still images (Approx.)*



When the  (Still) lamp is lights up:

	4.0M 2304 × 1728 4.0M
1GB	475
2GB	970
4GB	1900
8GB	3850

* All numbers measured when recording still images at the maximum image size. Check the actual number of recordable still images while recording still images on the LCD screen (p. 143).

When the  (Movie) lamp lights up:

The image size is fixed depending on the image quality and the aspect ratio of the movie recorded.

-  3.0M] with HD (high definition) image quality
-  3.0M] in the aspect ratio 16:9 with SD (standard definition) image quality
- [2.2M] in the aspect ratio 4:3 with SD (standard definition) image quality

Notes

- Numbers in the table are of when using a “Memory Stick PRO Duo” made by Sony Corporation. The recordable number of still images varies depending on the recording conditions or the type of “Memory Stick.”
- The unique pixel array of Sony’s ClearVid CMOS Sensor and image processing system (BIONZ) allows the still image resolution equivalent to the sizes described.

Tips

- For recording still images, you can use the “Memory Stick PRO Duo” that has 512 MB or less.

FILE NO.

► SERIES

Assigns file numbers of still images in sequence, even if you replace the “Memory Stick PRO Duo.”

RESET

Assigns individual file numbers for each “Memory Stick PRO Duo.”

NIGHTSHOT LIGHT

See page 86.

STEADYSHOT

See page 87.

GUIDEFAME

See page 88.

ZEBRA

See page 88.

FLASH MODE

See page 88.

FLASH LEVEL

See page 89.

REDEYE REDUC

See page 89.

FACE DETECTION

See page 89.

CONVERSION LENS

See page 90.

VIEW IMAGES SET

(Items to customize the display)



Touch ①, then ②.

If the item is not on the screen, touch ▲/▼ to change the page.

How to set

🏠 (HOME MENU) → page 84

⊕ (OPTION MENU) → page 98

The default settings are marked with ▶.

DATA CODE



During playback, displays the information (data code) recorded automatically at the time of recording.

▶ OFF

Data code is not displayed.

DATE/TIME

Displays the date and time.

CAMERA DATA

Displays camera setting data.

DATE/TIME

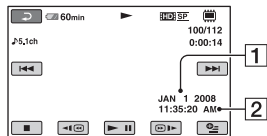

① Date

② Time

CAMERA DATA

Movie

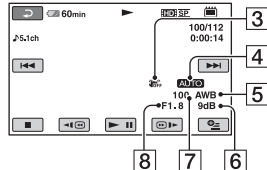

Still image

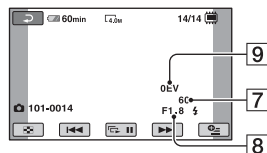

③ SteadyShot off

④ Brightness

⑤ White balance

⑥ Gain

⑦ Shutter speed

⑧ Aperture value

⑨ Exposure

💡 Tips

- ⚡ appears for a still image recorded using a flash.
- The data code is displayed on the TV screen if you connect your camcorder to a TV.
- The indicator toggles through the following sequences as you press DATA CODE on the Remote Commander: [DATE/TIME] → [CAMERA DATA] → [OFF] (no indication).
- Depending on the media condition, bars [---:---:---] appear.

DISPLAY



You can select the number of thumbnails that appear on the VISUAL INDEX screen or the Playlist.

Thumbnail Glossary (p. 145)

► ZOOM LINK

Change the number of thumbnails (6 or 12) with the power zoom lever on your camcorder.*

6IMAGES

Displays thumbnails of 6 images.

12IMAGES

Displays thumbnails of 12 images.

* You can also operate with the zoom buttons on the LCD frame or on the Remote Commander.

SOUND/DISP SET

(Items to adjust the sound and the screen)



Touch ①, then ②.

If the item is not on the screen, touch /
 to change the page.

How to set

(HOME MENU) → page 84

(OPTION MENU) → page 98

The default settings are marked with ►.

VOLUME



Touch / to adjust the volume (p. 46).

BEEP



► ON

A melody sounds when you start/stop recording, or operate the touch panel.

OFF

Cancels the melody or shutter sound.

LCD BRIGHT



You can adjust the brightness of the LCD screen.

① Adjust the brightness with /.

② Touch .

Tips

- This adjustment does not affect the recorded images in any way.

SOUND/DISP SET (Continued)

LCD BL LEVEL

You can adjust the brightness of the LCD screen's backlight.

► NORMAL

Standard brightness.

BRIGHT

Brightens the LCD screen.



Notes

- When you connect your camcorder to outside power sources, [BRIGHT] is automatically selected for the setting.
- When you select [BRIGHT], battery life is slightly reduced during recording.
- If you open the LCD panel 180 degrees to face the screen outside and close the LCD panel to the camcorder body, the setting becomes [NORMAL] automatically.

Tips

- This adjustment does not affect the recorded images in any way.

LCD COLOR

You can adjust the color of the LCD screen with  / .



Low intensity

High intensity

Tips

- This adjustment does not affect the recorded images in any way.

VF B.LIGHT

You can adjust the brightness of the viewfinder.

► NORMAL

Standard brightness.

BRIGHT

Brightens the viewfinder screen.

Notes

- When you connect your camcorder to outside power sources, [BRIGHT] is automatically selected for the setting.
- When you select [BRIGHT], battery life is slightly reduced during recording.

Tips

- This adjustment does not affect the recorded images in any way.

OUTPUT SETTINGS

(Items for connecting other devices)

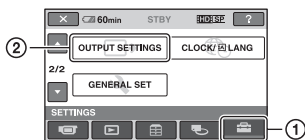

Touch ①, then ②.

If the item is not on the screen, touch ▲/▼ to change the page.

How to set

▲ (HOME MENU) → page 84

The default settings are marked with ►.

TV TYPE

You need to convert the signal depending on the TV connected when playing back the image. The recorded images are played back as following illustrations.

► 16:9

Select to view your images on a 16:9 (wide) TV.

16:9 (wide) images



4:3 images



4:3

Select to view your images on a 4:3 standard TV.

16:9 (wide) images



4:3 images



Notes

- The aspect ratio of the image recorded with HD (high definition) image quality is 16:9.
- When you connect your camcorder to a TV compatible with the ID-1/ID-2 system, set [TV TYPE] to [16:9]. The TV switches to full mode automatically. Refer also to the instruction manuals supplied your TV.

DISP OUTPUT

► LCD PANEL

Shows displays such as the time code on the LCD screen and in the viewfinder.

V-OUT/PANEL

Shows displays such as the time code on the TV screen, LCD screen, and in the viewfinder.

COMPONENT

Select [COMPONENT] when connecting your camcorder to a TV with the component input jack.

480i

Select when connecting your camcorder to a TV with the component input jack.

► 1080i/480i



Select when connecting your camcorder to a TV that has the component input jack and is capable of displaying the 1080i signal.

CLOCK/LANG

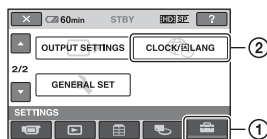
(Items to set clock and language)



Touch ①, then ②.

If the item is not on the screen, touch /
 to change the page.

How to set



 (HOME MENU) → page 84

CLOCK SET

See page 25.

AREA SET

You can adjust a time difference without stopping the clock.

Set your local area using /
 when using your camcorder in other time zones.

Refer to the world time difference on page 125.

DST SET/SUMMERTIME

You can change this setting without stopping the clock.

Set to [ON] to move the time forward 1 hour.

LANGUAGE SET

You can select the language to be used on the LCD screen.

Tips



- Your camcorder offers [ENG[SIMP]] (simplified English) for when you cannot find your native tongue among the options.

GENERAL SET

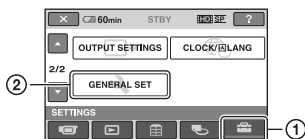
(Other setup items)



Touch ①, then ②.

If the item is not on the screen, touch /
 to change the page.

How to set



 (HOME MENU) → page 84

The default settings are marked with .

DEMO MODE

The default setting is [ON], allowing you to view the demonstration in about 10 minutes, after you turn on your camcorder and light up the  (Movie) lamp.

Tips

- The demonstration will be suspended in situations such as those described below.
 - When you press START/STOP or PHOTO.
 - When you press DUBBING button (HDR-UX20)
 - When you touch the screen during the demonstration. (The demonstration starts again after about 10 minutes.)
 - When you slide the disc cover OPEN switch.
 - When you light up the  (Still) lamp by sliding the POWER switch.
 - When you press  (HOME)/ (VIEW IMAGES).

REC LAMP (Recording lamp)

The camera recording lamp on the front of your camcorder lights up, as the default setting is [ON].

CALIBRATION

See page 132.

A.SHUT OFF (Auto shut off)



► 5 min

The camcorder is automatically turned off when you do not operate your camcorder for more than approximately 5 minutes.

NEVER

The camcorder is not automatically turned off.

🔌 Notes

- When you connect your camcorder to a wall outlet (wall socket), [A.SHUT OFF] is automatically set to [NEVER].

QUICK ON STBY



You can set the desired turn off time of the camcorder with [QUICK ON STBY] while the Sleep mode is set (p. 41). The default setting is [10min].

🔌 Notes

- While the Sleep mode is set, the setting of [A.SHUT OFF] becomes ineffective.

REMOTE CTRL (Remote control)



The default setting is [ON], allowing you to use the supplied Remote Commander (p. 142).

💡 Tips

- Set to [OFF] to prevent your camcorder from responding to a command sent by another VCR remote control unit.

CTRL FOR HDMI



The default setting is [ON], allowing you to do the playback operation with the remote commander of your TV by connecting your camcorder to a “BRAVIA” Sync compatible TV with the HDMI cable (optional) (p. 54).

Activating functions using the OPTION MENU

The  (OPTION MENU) appears just like the pop-up window that appears when you right-click the mouse on a computer. Various available functions are displayed.

Using the OPTION MENU

- 1 While using your camcorder, touch  (OPTION) on the screen.

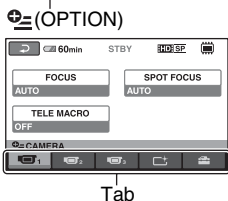
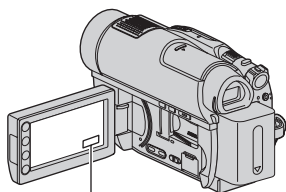

- 2 Touch the desired item.

If you cannot find the desired item, touch another tab to change the page.

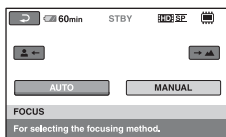



If you cannot find the item anywhere, the function does not work under the current situation.

- 3 Change the setting, then touch .



Notes

- The tabs and items that appear on the screen depend on the recording/playback status of your camcorder at the time.
- Some items appear without a tab.
- During Easy Handycam operation, you cannot use the .

Recording items on the OPTION MENU



Items	 ^{*1}	Page
 tab		
FOCUS	–	100
SPOT FOCUS	–	100
TELE MACRO	–	100
EXPOSURE	–	101
SPOT METER	–	101
SCENE SELECTION	–	101
WHITE BAL.	–	102
COLOR SLOW SHTR	–	103
SUPER NIGHTSHOT	–	103

 tab		
FADER	–	103
D.EFFECT	–	104
PICT.EFFECT	–	104

 tab		
REC MODE	○	86
BLT-IN ZOOM MIC	–	104
MICREF LEVEL	–	104
 IMAGE SIZE	○	90
SELF-TIMER	–	104







Items	 *1	Page
FLASH MODE	○	88
TIMING	–	42
RECORD SOUND	–	43

Viewing items on the OPTION MENU

Items	 *1	Page
 tab		
DELETE *2	○	57
DELETE by date *2	○	57
DELETE ALL *2	○	57

 tab		
DIVIDE	○	64
ERASE *2	○	66
ERASE ALL *2	○	66
MOVE *2	○	67

-- (A tab depends on the situation)/ (No tab)

 ADD *2	○	65
 ADD *2	○	65
 ADD *2	○	65
 ADD by date *2	○	65
 ADD by date *2	○	65
 ADD ALL *2	○	65
PRINT	○	70
SLIDE SHOW	–	49
VOLUME	○	46
DATA CODE	○	92
SLIDE SHOW SET	–	49
COPIES	–	70
DATE/TIME	–	70
SIZE	–	70
DISC MENU *3	–	75

*1 Items that are included in the HOME MENU also.

*2 These items also available in the HOME MENU, but with different item names.

*3 [DVD MENU] for SD (standard definition) image quality

Functions set in the OPTION MENU





Items you can set only on the  (OPTION MENU) will be described below.

The default settings are marked with .

FOCUS

You can adjust the focus manually. You can select this function also when you want to focus on a certain subject intentionally.



- 1 Touch [MANUAL].
 appears.
- 2 Touch  (focusing on close subjects)/
 (focusing on distant subjects) to sharpen the focus.  appears when the focus cannot be adjusted any closer, and  appears when the focus cannot be adjusted farther away.
- 3 Touch [OK].

To adjust the focus automatically, touch [AUTO] → [OK] in step 1.

Notes

- The minimum possible distance between camcorder and subject while maintaining sharp focus is about 1 cm (about 13/32 in.) for wide angle and about 80 cm (about 2 5/8 feet) for telephoto.

Tips

- It is easier to focus on the subject by moving the power zoom lever towards T (telephoto) to adjust the focus, then towards W (wide angle) to adjust the zoom for recording. When you want to record a subject at close range, move the power zoom lever to W (wide angle), then adjust the focus.
- The focal distance information (distance at which the subject is focused on, if it is dark and focus adjustment is difficult) appears for a few seconds in the following cases (This information will not display correctly if an optional conversion lens is being used).
 - When the focus mode is switched from automatic to manual.
 - When you set focus manually.

SPOT FOCUS

You can select and adjust the focal point to aim it at a subject not located at the center of the screen.

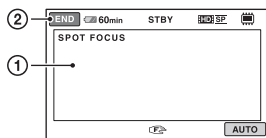

- 1 Touch the subject on the screen.
 appears.
- 2 Touch [END].

To adjust the focus automatically, touch [AUTO] → [END] in step 1.

Notes

- If you set [SPOT FOCUS], [FOCUS] is automatically set to [MANUAL].

TELE MACRO

This is useful to shoot small subjects, such as flowers or insects. You can blur out backgrounds and the subject stands out clearer.

When you set [TELE MACRO] to [ON] () , the zoom (p. 40) moves to the top of the T (telephoto) side automatically and allows recording subjects at a close distance, down to about 57 cm (22 1/2 in.).



To cancel, touch [OFF], or zoom to wide-angle (W side).

Notes

- When recording a distant subject, focusing may be difficult and can take some time.
- Adjust the focus manually ([FOCUS], p. 100) when it is hard to focus automatically.

EXPOSURE



You can fix the brightness of a picture manually. Adjust the brightness when the subject is too bright or too dark relative to the background.

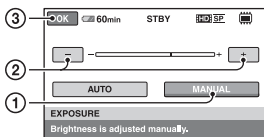

- ① Touch [MANUAL].
————— appears.
- ② Adjust the exposure by touching —/ +.
- ③ Touch [OK].

To return the setting to automatic exposure, touch [AUTO] → [OK] in step ①.

SPOT METER (Flexible spot meter)



You can adjust and fix the exposure to the subject, so that it is recorded in suitable brightness even when there is strong contrast between the subject and the background, such as subjects in the spotlight on stage.

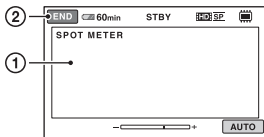

- ① Touch the point where you want to fix and adjust the exposure on the screen.
————— appears.
- ② Touch [END].

To return the setting to automatic exposure, touch [AUTO] → [END] in step ①.

Notes

- If you set [SPOT METER], [EXPOSURE] is automatically set to [MANUAL].

SCENE SELECTION



You can record images effectively in various situations.

▶ AUTO

Select to automatically record images effectively without the [SCENE SELECTION] function.

TWILIGHT* (☾)

Select to maintain the darkening atmosphere of the distant surroundings in twilight scenes.



TWILIGHT PORT.(☺☺)

Select to use the flash when recording still images of persons and background.



CANDLE (🕯)

Select to maintain the dim atmosphere of a candlelit scene.



SUNRISE&SUNSET (☀️)

Select to reproduce the atmosphere of scenes such as sunsets or sunrises.



FIREWORKS* (💣)

Select to take spectacular shots of fireworks.



LANDSCAPE* ()

Select to shoot distant subjects clearly. This setting also prevents your camcorder from focusing on glass or metal mesh in windows that comes in between the camcorder and the subject.



PORTRAIT ()

Select to bring out the subject such as people or flowers while creating a soft background.



SPOTLIGHT** ()

Select to prevent people's faces from appearing excessively white when subjects are lit by strong light.



BEACH** ()

Select to take the vivid blue of the ocean or a lake.



SNOW** ()



Select to take bright pictures of a white landscape.



* Adjusted to focus on subjects farther away only.

** Adjusted not to focus on subjects a short distance away.

Notes

- Even when [SCENE SELECTION] has been set to [TWILIGHT PORT.] with the  lamp lighting up, the settings automatically changed to [AUTO] according to the lighting-up of the  lamp.
- If you set [SCENE SELECTION], [WHITE BAL.] setting is canceled.

WHITE BAL. (White balance)



You can adjust the color balance to the brightness of the recording environment.

▶ AUTO

The white balance is adjusted automatically.

OUTDOOR ()

The white balance is adjusted to be appropriate for the following recording conditions:

- Outdoors
- Night views, neon signs and fireworks
- Sunrise or sunset
- Under daylight fluorescent lamps

INDOOR ()



The white balance is adjusted to be appropriate for the following recording conditions:

- Indoors
- At party scenes or studios where the lighting conditions change quickly
- Under video lamps in a studio, or under sodium lamps or incandescent-like color lamps



ONE PUSH ()

The white balance will be adjusted according to the ambient light.

- ① Touch [ONE PUSH].
- ② Frame a white object such as a piece of paper, to fill the screen under the same lighting conditions as you will shoot the subject.

- ③ Touch .  flashes quickly. When the white balance has been adjusted and stored in the memory, the indicator stops flashing.

🔌 Notes

- Set [WHITE BAL.] to [AUTO] or adjust the color in [ONE PUSH] under white or cool white fluorescent lamps.
- When you select [ONE PUSH], keep shooting a white object while  is flashing quickly.
-  flashes slowly if [ONE PUSH] could not be set.
- When [ONE PUSH] was selected, if  keeps flashing after touching [OK], set [WHITE BAL.] to [AUTO].
- If you set [WHITE BAL.], [SCENE SELECTION] is set to [AUTO].

💡 Tips

- If you have changed the battery pack while [AUTO] was selected, or bring your camcorder outdoors from inside the house, or vice versa, select [AUTO] and aim your camcorder at a nearby white object for about 10 seconds for better color balance adjustment.
- When the white balance has been set with [ONE PUSH], if you change the [SCENE SELECTION] settings, or bring your camcorder outdoors from inside the house, or vice versa, you need to redo the [ONE PUSH] procedure to readjust the white balance.

COLOR SLOW SHTR (Color Slow Shutter)



When you set [COLOR SLOW SHTR] to [ON],  appears, and you can record an image brighter in color even in dark places.

To cancel [COLOR SLOW SHTR], touch [OFF].

🔌 Notes

- Adjust the focus manually ([FOCUS], p. 100) when it is hard to focus automatically.
- The shutter speed of your camcorder changes depending on the brightness, which may result in a slowdown of the motion of the image.

SUPER NIGHTSHOT



The image will be recorded at a maximum of 16 times the sensitivity of NightShot recording if you set [SUPER NIGHTSHOT] to [ON] while the NIGHTSHOT switch (p. 41) is also set to ON.

 appears on the screen.

To return to the normal setting, set [SUPER NIGHTSHOT] to [OFF].

🔌 Notes

- Do not use [SUPER NIGHTSHOT] in bright places. This may cause a malfunction.
- Do not cover the infrared port with your fingers or other objects (p. 41).
- Remove the conversion lens (optional).
- Adjust the focus manually ([FOCUS], p. 100) when it is hard to focus automatically.
- The shutter speed of your camcorder changes depending on the brightness, which may result in a slowdown of the motion of the image.

FADER



You can record a transition with the following effects adding to the interval between scenes.

- ① Select the desired effect in [STBY] (to fading in) or [REC] (to fading out) mode, then touch [OK].
- ② Press START/STOP.

The fader indicator stops flashing and disappears when the fade is complete.

To cancel the fader before starting the operation, touch [OFF] in step ①. If you press START/STOP, the setting is canceled.



Functions set in the OPTION MENU (Continued)

WHITE FADER



BLACK FADER



D.EFFECT (Digital effect)

When you set [OLD MOVIE],  appears and you can add an old movie effect to images.

To cancel [D.EFFECT], touch [OFF].

PICT.EFFECT (Picture effect)

You can add special effects to an image during recording.  appears.

► OFF

Does not use [PICT.EFFECT] setting.

SEPIA

Images appear in sepia.

B&W

Images appear in black and white.

PASTEL



Images appear as a pale pastel drawing.

BLT-IN ZOOM MIC

When you set [BLT-IN ZOOM MIC] to [ON] () , you can record sound with directivity as you move the power zoom lever. The default setting is [OFF].

MICREF LEVEL (Mic reference level)

You can select the microphone level for recording sound.

Select [LOW] when you want to record exciting and powerful sound in a concert hall, etc.

► NORMAL

Records various surround sounds, converting them into the certain level.

LOW (↓)

Records surround sound faithfully. This setting is not suitable for recording conversations.

SELF-TIMER

When you set [SELF-TIMER] to [ON],  appears. Press PHOTO to start the count down, then record a still image after about 10 seconds.

To cancel recording, touch [RESET].

To cancel the self-timer, select [OFF].

Tips

- You can also operate by pressing PHOTO on the Remote Commander (p. 142).

What you can do with Windows computer

When you install the “Picture Motion Browser” on a Windows computer from the supplied CD-ROM, you can enjoy the following operations.

- **Playing a disc in the AVCHD format**
→ **Player for AVCHD**
- **Importing images recorded on your camcorder**
- **Viewing imported images on a computer**
- **Creating a disc in the AVCHD format**
- **Copying a disc**
→ **Video Disc Copier**

For details on the functions of “Picture Motion Browser,” see “PMB Guide.”

🔍 Notes

- This camcorder captures high definition footage in the AVCHD format. Using the enclosed PC software, high definition footage can be copied onto DVD media. However, DVD media containing AVCHD footage should not be used with DVD based players or recorders, as the DVD player/recorder may fail to eject the media and may erase its contents without warning. DVD media containing AVCHD footage may be played on a compatible Blu-ray Disc<TM> player/recorder or other compatible device.

■ Using a Macintosh computer

The supplied software “Picture Motion Browser” does not support a Macintosh computer.

On the advanced use of images on your camcorder connected to your computer, see the following URL;

<http://guide.d-imaging.sony.co.jp/mac/ms/us/>

Installing the software

■ System requirements for using “Picture Motion Browser”

OS: Microsoft Windows 2000 Professional SP4/Windows XP SP2*/Windows Vista*

* 64-bit editions and Starter (Edition) are not supported.

- Standard installation is required.
- Operation is not assured if the above OS has been upgraded or in a multi-boot environment.

CPU: Intel Pentium 4 2.8 GHz or faster (Intel Pentium 4 3.6 GHz or faster, Intel Pentium D 2.8 GHz or faster, Intel Core Duo 1.66 GHz or faster, Intel Core 2 Duo 1.66 GHz or faster is recommended.)

- The following operations are possible with Intel Pentium III 1 GHz or faster.

- Importing the contents to the computer
- Creating an AVCHD format disc/DVD video
- Copying a disc
- Processing only the contents in SD (standard definition) image quality

Application: DirectX 9.0c or later (This product is based on DirectX technology. It is necessary to have DirectX installed.)

Sound system: Direct Sound-compatible sound card

Memory: Windows 2000, Windows XP: 512 MB or more (1 GB or more is recommended.)

For processing SD (standard definition) image quality content only, 256 MB of memory or more is necessary.

Windows Vista:
1 GB or more

Hard disk: Disc volume required for installation:

Approximately 500 MB (10 GB or more may be necessary when creating AVCHD format discs.)

Display: Minimum 1024 × 768 dots

Others: 🖱️ USB port (this must be provided as standard, Hi-Speed USB (USB 2.0 compatible) is recommended), DVD burner (CD-ROM drive is necessary for installation)

What you can do with Windows computer (Continued)

🔊 Notes

- In addition to the above, you need a computer that fulfills appropriate system requirements to operate the OS installed on the computer.
- Even in a computer environment where the operations are guaranteed, frames may be dropped from movies, resulting in uneven playback. However, imported images and images on discs created subsequently will not be affected.
- Operations are not guaranteed, even on computers fulfilling the above system requirements. For example, other open or background applications currently running may limit product performance.
- “Picture Motion Browser” does not support 5.1ch surround sound reproduction. The sound is reproduced in 2ch sound.
- 8 cm media (DVD+R DL (double layer) etc.) may not be able to use, depending on the computer used.
- If you use a Notebook PC, connect it to the AC Adaptor as the power source when you view or edit movies. Otherwise, the software will not work properly due to the power saving function of the computer.
- You can view images recorded on a “Memory Stick PRO Duo” in a Memory Stick slot of a computer. However, in the following cases, do not use the Memory Stick slot of the computer, but connect your camcorder to the computer with the USB cable:
 - The computer is not compatible with a “Memory Stick PRO Duo.”
 - A Memory Stick Duo adaptor is required.
 - A “Memory Stick PRO Duo” cannot be read in the Memory Stick slot.
 - Reading data from the Memory Stick slot is slow.

■ Installation procedure

Before connecting your camcorder to the computer, you need to install the software to your Windows computer. The installation is required only for the first time.

Contents to be installed and procedures may differ depending on your OS.

- ① Confirm that your camcorder is not connected to the computer.
- ② Turn on the computer.

🔊 Notes

- Log on as Administrators for installation.
 - Close all applications running on the computer before installing the software.
- ③ Place the supplied CD-ROM in the disc drive of your computer.
The installation screen appears.



If the screen does not appear

- ① Click [Start], then click [My Computer]. (For Windows 2000, double-click [My Computer].)
- ② Double-click [SONYPICUTIL (E:)] (CD-ROM) (disc drive).
 - * Drive names (such as (E:)) may vary depending on the computer.
- ④ Click [Install].
- ⑤ Select the language for the application to be installed, then click [Next].
- ⑥ As the screen to confirm the connection appears, connect your camcorder to the computer following the steps below.
 - ① Connect the AC Adaptor to the DC IN jack on your camcorder and the wall outlet (wall socket).
 - ② Turn on your camcorder.
 - ③ Connect the Ψ (USB) jack (p. 140) of your camcorder to the computer using the supplied USB cable.
 - ④ Touch [ USB CONNECT] on the screen of your camcorder.

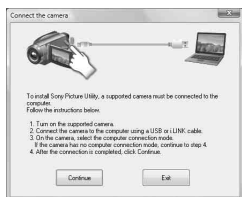

- ⑦ Click [Continue].
- ⑧ Read [License Agreement], select [I accept the terms of the license agreement] if you agree, then click [Next].
- ⑨ Confirm the installation settings, then click [Install].

⚡ Notes

- Even if a screen prompting you to restart your computer appears, you do not need to restart it at this time. Restart your computer after completing the installation.
 - It may take some time for the authentication.
- ⑩ Follow the on-screen instructions to install the software.

The following installation screens may be displayed, depending on your operating environment. In this case, follow the instructions on the screen to install the software.

- **Sonic UDF Reader***
Software required to recognize an AVCHD format discs
 - **Windows Media Format 9 Series Runtime** (Windows 2000 only)
Software required to create a DVD video disc
 - **Microsoft DirectX 9.0c***
Software required to handle movies
- * Windows 2000, Windows XP only

- ⑪ Restart the computer if required to complete the installation.



- ⑫ Remove the CD-ROM from the disc drive of your computer.

■ Operating the “Picture Motion Browser”

To start “Picture Motion Browser,” click [start] → [All Programs] → [Sony Picture Utility] → [PMB-Picture Motion Browser].

For the basic operation of “Picture Motion Browser,” see “PMB Guide.” To start “PMB Guide,” click [start] → [All Programs] → [Sony Picture Utility] → [Help] → [PMB Guide].

■ Connecting your camcorder to a computer

To connect your camcorder to a computer, follow the steps below.

- ① Connect the AC Adaptor to the DC IN jack on your camcorder and the wall outlet (wall socket).
- ② Turn on your camcorder.
- ③ Connect ψ (USB) jack (p. 140) of your camcorder to the computer using the supplied USB cable.
The [USB SELECT] screen appears on the screen of your camcorder. Touch the item you want to operate on the screen.

💡 Tips

- If the [USB SELECT] screen does not appear, touch \uparrow (HOME) → ☰ (OTHERS) → [USB CONNECT].

Recommended USB cable connection

To assure the proper functioning of your camcorder, connect your camcorder to a computer as below.

What you can do with Windows computer (Continued)

- Do not connect anything to other USB ports of a computer.
- When connecting to a computer with a USB keyboard and USB mouse connected as standard equipment, connect your camcorder to another USB port using the USB cable.

🔊 Notes

- Operations are not guaranteed when multiple USB devices are connected to a computer.
- Be sure to connect the USB cable to a USB port. If the USB cable is connected to a computer via a USB keyboard or USB hub, operations are not guaranteed.

- Before turning off your camcorder, disconnect the USB cable following the proper procedures described above.
- Disconnect the USB cable using the proper procedures described above. Otherwise, files stored on the media may not be updated correctly. Also, disconnecting the USB cable improperly may cause a malfunction of the media.

To disconnect the USB cable

- ① Click the [Unplug or eject hardware] icon on the task tray on the bottom right of the desk top.



- ② Click [Safely remove USB Mass Storage Device].

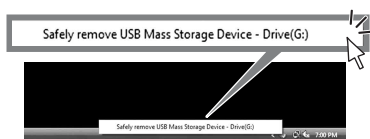

- ③ Click [OK] (Windows 2000 only).
- ④ Touch [END] on the screen of your camcorder.
- ⑤ Touch [YES] on the screen of your camcorder.
- ⑥ Disconnect the USB cable from your camcorder and the computer.

🔊 Notes

- Do not disconnect the USB cable while the ACCESS lamp/access lamp is lit.

Troubleshooting

If you run into any problems using your camcorder, use the following table to troubleshoot the problem. If the problem persists, disconnect the power source and contact your Sony dealer.

- Overall operations/Easy Handycam operation/Remote Commander p. 109
- Batteries/Power sources p. 111
- LCD screen/viewfinder p. 111
- Media..... p. 112
- Recording p. 112
- Playing back images on your camcorder p. 114
- Playing back a disc on other devices p. 115
- Playing back a “Memory Stick PRO Duo” on other devices..... p. 116
- Editing images on your camcorder p. 116
- Viewing images on the TV p. 117
- Dubbing to other devices p. 118
- Connecting to a computer p. 118
- Functions that cannot be used simultaneously..... p. 118

Overall operations/Easy Handycam operation/Remote Commander

The power does not turn on.

- Attach a charged battery pack to the camcorder (p. 22).
- The plug of the AC Adaptor has been disconnected from the wall outlet (wall socket). Connect it to the wall outlet (wall socket) (p. 22).

The camcorder does not operate even when the power is set to on.

- It takes a few seconds for your camcorder to be ready to shoot after the power is turned on. This is not a malfunction.

- Disconnect the AC Adaptor from the wall outlet (wall socket) or remove the battery pack, then reconnect it after about 1 minute. If the functions still do not work, press the RESET button (p. 140) using a pointed object. (If you press the RESET button, all settings, including the clock setting, are reset.)
- The temperature of your camcorder is extremely high. Turn off your camcorder and leave it for a while in a cool place.

Buttons do not work.

- During Easy Handycam operation (p. 34), you cannot use following buttons/functions.
 - To turn on and off the LCD backlight (Pressing and holding DISP/BATT INFO for a few seconds) (p. 27)
 -  (back light) (p. 42)
 - Playback zoom (p. 48)
 - DUBBING button (HDR-UX20) (p. 61)

(OPTION) does not appear on the screen.





- The OPTION MENU cannot be used during Easy Handycam operation.

The menu settings have changed automatically.

- During Easy Handycam operation, nearly all the menu items will be automatically set to the default settings.
- During Easy Handycam operation, some menu items are fixed as follows.
 - [REC MODE]: [HD SP]/[SD SP]
 - [DATA CODE]: [DATE/TIME]
 - Recording format of DVD-RW: [VIDEO] (for SD (standard definition) image quality)
- Following menu items return to the default settings when you set the POWER switch to OFF (CHG) for more than 12 hours.
 - [DISC MENU]/DVD menu
 - [FLASH MODE]
 - [FOCUS]
 - [SPOT FOCUS]
 - [EXPOSURE]

- [SPOT METER]
- [SCENE SELECTION]
- [WHITE BAL.]
- [COLOR SLOW SHTR]
- [SUPER NIGHTSHOT]
- [BLT-IN ZOOM MIC]
- [MICREF LEVEL]

Even if you press EASY, menu settings do not switch to their defaults automatically.

- During Easy Handycam operation, settings for the following menu items are maintained the ones before Easy Handycam operation.
 - [MOVIE MEDIA SET]
 - [PHOTO MEDIA SET]*
 - [AUDIO MODE]
 - [WIDE SELECT]
 - [X.V.COLOR]
 - [SUB-T DATE]
 - [FLASH MODE]
 - [ INDEX SET]
 - [CONVERSION LENS]
 - [ IMAGE SIZE]
 - [FILE NO.]
 - [ DISPLAY]
 - [VOLUME]
 - [BEEP]
 - [TV TYPE]
 - [COMPONENT]
 - [CLOCK SET]
 - [AREA SET]
 - [DST SET]/[SUMMERTIME]
 - [ LANGUAGE SET]
 - [DEMO MODE]
 - [CTRL FOR HDMI]
- *HDR-UX20

Your camcorder vibrates.

- Vibration occurs depending on the condition of the disc. This is not a malfunction.

A vibration is felt in your hand or a faint sound is heard during operation.

- This is not a malfunction.

A motor sound is heard in the camcorder when the disc cover is closed without a disc.

- Your camcorder is trying to recognize the disc. This is not a malfunction.

Your camcorder gets warm.

- This is because the power has been turned on for a long time. This is not a malfunction. Turn off your camcorder and leave it for a while in a cool place.

The supplied Remote Commander does not function.

- Set [REMOTE CTRL] to [ON] (p. 97).
- Insert a battery into the battery holder with the +/- polarities correctly matching the +/- marks (p. 142).
- Remove any obstructions between the Remote Commander and the remote sensor.
- Point the remote sensor away from strong light sources such as direct sunlight or overhead lighting. Otherwise, the Remote Commander may not function properly.

Another DVD device malfunctions when you use the supplied Remote Commander.

- Select a commander mode other than DVD 2 for your DVD device, or cover the sensor of your DVD device with black paper.

Batteries/Power sources

The power abruptly turns off.

- When approximately 5 minutes have elapsed while you do not operate your camcorder, the camcorder is automatically turned off (A.SHUT OFF). Change the setting of [A.SHUT OFF] (p. 97), or turn on the power again, or use the AC Adaptor.
- If the time set with [QUICK ON STBY] (p. 97) has elapsed in the Sleep mode, your camcorder turns off automatically. Turn on your camcorder again.
- The battery pack is discharged or running low. Charge the battery pack (p. 22).

The CHG (charge) lamp does not light while the battery pack is being charged.

- Slide the POWER switch to OFF (CHG) (p. 22).
- Attach the battery pack to the camcorder correctly (p. 22).
- Connect the power cord (mains lead) to the wall outlet (wall socket) properly.
- The battery charge is completed (p. 22).

The CHG (charge) lamp flashes while the battery pack is being charged.

- Attach the battery pack to the camcorder correctly (p. 22). If the problem persists, disconnect the AC Adaptor from the wall outlet (wall socket) and contact your Sony dealer. The battery pack may be damaged.

The remaining battery time indicator does not indicate the correct time.

- The temperature of the environment is too high or too low. This is not a malfunction.
- The battery pack has not been charged enough. Fully charge the battery again. If the problem persists, replace the battery pack with a new one (p. 22).
- The indicated time may not be correct depending on the environment of use.

The battery pack is quickly discharged.

- The temperature of the environment is too high or low. This is not a malfunction.
- The battery pack has not been charged enough. Fully charge the battery again. If the problem persists, replace the battery pack with a new one (p. 22).

LCD screen/viewfinder

Menu items are grayed out.

- You cannot select grayed items in the current recording/playback situation.
- There are some functions you cannot activate simultaneously (p. 118).

The buttons do not appear on the touch panel.

- Touch the LCD screen lightly.
- Press DISP/BATT INFO on your camcorder (or DISPLAY on the Remote Commander) (p. 27, 142).

The buttons on the touch panel do not work correctly or do not work at all.

- Adjust the touch panel ([CALIBRATION]) (p. 132).

The image in the viewfinder is not clear.

- Pull out the viewfinder, then move the viewfinder lens adjustment lever until the image appears clearly (p. 27).

The image in the viewfinder has disappeared.

- Close the LCD panel. No image is displayed in the viewfinder when the LCD panel is open (p. 27).

Media

The disc cannot be removed.

- Make sure the power source (battery pack or AC Adaptor) is connected correctly (p. 22).
- The disc is damaged or is dirty with fingerprints, etc. In this case, it may take up to 10 minutes to remove the disc.
- The temperature of your camcorder is extremely high. Turn off your camcorder and leave it for a while in a cool place.
- Finalizing is interrupted by turning off your camcorder. Turn on your camcorder and remove the disc after finalizing is completed (p. 73).

Images on a disc cannot be deleted.

- The maximum number of images that you can delete on the index screen at one time is 100.
- Movies on a disc cannot be deleted depending on the followings.
 - Movies recorded on DVD-R/DVD+R DL
 - Movies with SD (standard definition) image quality other than the most recent movie on DVD-RW with the VIDEO mode
 - Movies with SD (standard definition) image quality other than the most recent movie on DVD+RW

The indicators of the disc type and the recording format on the LCD screen are grayed out.

- The disc may have been created with a device other than your camcorder. You can play back the disc with your camcorder, but you cannot record additional scenes.
- This disc is not a media compatible with the camcorder.
- The camcorder may have failed to recognize the disc.

You cannot operate functions using the “Memory Stick PRO Duo.”

- If you use a “Memory Stick PRO Duo” formatted on a computer, format it again on your camcorder (p. 78).

You cannot delete images stored on the “Memory Stick PRO Duo.”

- The maximum number of images that you can delete on the index screen at one time is 100.
- You cannot delete the images protected on another device.

The data file name is not indicated correctly or flashes.

- The file is damaged.
- The file format is not supported by your camcorder (p. 129).

Recording

Refer also to “Media” (p. 112).

Pressing START/STOP or PHOTO does not record images.

- The playback screen is displayed. Set your camcorder to recording standby (p. 39).
- Recordings cannot be performed in the Sleep mode. Press QUICK ON again (p. 41).
- Your camcorder is recording the image data you have just shot on the media. You cannot make new recording during this period.
- The media of the camcorder is full. Format the media (Internal memory (HDR-UX20)/DVD-RW/DVD+RW/“Memory Stick PRO Duo” only, p. 78) or delete unnecessary images (p. 57). Or use the new disc or “Memory Stick PRO Duo.”

- When you are using one of the following discs after finalizing it, make the disc to be able to record additional scenes (p. 80). Or use a new disc.
 - DVD+RW
 - DVD-RW recorded with HD (high definition) image quality
 - DVD-RW (VIDEO mode) recorded with SD (standard definition) image quality
- The temperature of your camcorder is extremely high. Turn off your camcorder and leave it for a while in a cool place.
- Moisture condensation has occurred. Turn off your camcorder and leave it for about 1 hour (p. 132).
- Total number of still images exceeds the recordable capacity of your camcorder (p. 90). Delete unnecessary images (p. 57).

You cannot record a still image.

- You cannot record a still image during recording a movie together with:
 - [SMTH SLW REC]
 - [FADER]
 - [D.EFFECT]
 - [PICT.EFFECT]
- You cannot record a still image on a disc on your camcorder.

The ACCESS lamp/access lamp lights up even when you stop recording.

- Your camcorder is recording the image data you have just record on the media.

The recording angle looks different.

- The recording angle may look different depending on the mode of your camcorder. This is not a malfunction.

The flash does not work.

- You cannot record with the flash when capturing still images while recording a movie (p. 41).

- Even if [FLASH MODE] is set to [AUTO], you cannot use the flash with:
 - NightShot
 - [MANUAL] in [EXPOSURE]
 - [SPOT METER]
 - [TWILIGHT], [CANDLE], [SUNRISE&SUNSET], [FIREWORKS] [LANDSCAPE], [SPOTLIGHT], [BEACH] or [SNOW] in [SCENE SELECTION]
 - [SUPER NIGHTSHOT]

The actual recording time for movie is less than the expected approximate recording time.

- Depending on the recording situation, such as recording a fast moving object, the time available for recording may shorten (p. 17, p. 33).

The recording stops.

- The temperature of your camcorder is extremely high. Turn off your camcorder and leave it for a while in a cool place.
- Moisture condensation has occurred. Turn off your camcorder and leave it about 1 hour (p. 132).

There is a time difference between the point where you press START/STOP and the point that the recorded movie starts/stops.

- On your camcorder, there may be a slight time difference between the point where you press START/STOP and the actual point that recording movie starts/stops. This is not a malfunction.

The movie aspect ratio (16:9/4:3) cannot be changed.

- You cannot change the aspect ratio when:
 - recording movies with HD (high definition) image quality.
 - recording movies on DVD+RW with SD (standard definition) image quality.

Troubleshooting (Continued)

- there is no media that has been set on [MOVIE MEDIA SET] in your camcorder.

The auto focus does not function.

- Set [FOCUS] to [AUTO] (p. 100).
- The recording conditions are not suitable for auto focus. Adjust the focus manually (p. 100).

[STEADYSHOT] does not function.

- Set [STEADYSHOT] to [ON] (p. 87).
- [STEADYSHOT] may not be able to compensate for excessive vibrations.

The subjects passing by the screen very fast appear crooked.

- This is called the focal plane phenomenon. This is not a malfunction. Because of the way the image device (CMOS sensor) reads out image signals, the subjects passing by the lens rapidly might appear crooked depending on the recording conditions.

Tiny spots in white, red, blue, or green appear on the screen.

- The spots appear when you are recording with [SUPER NIGHTSHOT] or [COLOR SLOW SHTR]. This is not a malfunction.

The color of the image is not correctly displayed.

- Set the NIGHTSHOT switch to OFF (p. 41).

The screen image is bright, and the subject does not appear on the screen.

- Set the NIGHTSHOT switch to OFF (p. 41).

The screen image is dark, and the subject does not appear on the screen.

- Press and hold DISP/BATT INFO for a few seconds to turn on the backlight (p. 27).

Horizontal stripes appear on the image.

- This occurs when recording images under a fluorescent lamp, sodium lamp, or mercury lamp. This is not a malfunction.

[SUPER NIGHTSHOT] cannot be operated.

- Set the NIGHTSHOT switch to ON.

[COLOR SLOW SHTR] does not operate correctly.



- [COLOR SLOW SHTR] may not operate correctly in total darkness. Use NightShot or [SUPER NIGHTSHOT].

You cannot adjust [LCD BL LEVEL].

- You cannot adjust [LCD BL LEVEL] when:
 - The LCD panel is closed on your camcorder with the LCD screen facing out.
 - The power is supplied from the AC Adaptor.

Playing back images on your camcorder

An image cannot be found for playback.

- Set the desired media of images for playback or for image quality by touch  (HOME) →  (MANAGE MEDIA) → [MOVIE MEDIA SET] or [PHOTO MEDIA SET] (HDR-UX20) (p. 28).

You cannot play back a disc.

- Check out the disc compatibility (p. 16).
- Insert a disc with the recording side facing your camcorder (p. 30).
- The disc that was recorded, formatted, or finalized on other devices may not be played back on your camcorder.
- The temperature of your camcorder is extremely high. Turn off your camcorder and leave it for a while in a cool place.

The playback image is distorted.

- Clean the disc using a soft cloth (p. 128).

Images stored on a “Memory Stick PRO Duo” cannot be played back.

- Images cannot be played back if you have modified files or folders, or have edited the data on a computer. (On the still image playback screen, the file name flashes in that case.) This is not a malfunction (p. 130).
- Images recorded on other devices may not be played back, or may be displayed in wrong size. This is not a malfunction (p. 130).

“?” is indicated on an image in the VISUAL INDEX screen.

- Loading of the data may have failed. It may be indicated correctly when you turn off the power and then turn it on again, or repeat removing and inserting the “Memory Stick PRO Duo” a couple of times.
- You disconnect the AC Adaptor or removed the battery pack before the access lamp is turned off after recording. This may damage your image data and “?” is displayed.
- This may appear on still images recorded on other devices, edited on a computer, etc.

“?” is indicated on an image in the VISUAL INDEX screen.

- Execute [REPAIR IMG.DB F.] (p. 82). If it still appears, delete the image with [?] (p. 57).

No sound or only a quiet sound is heard during playback.

- Turn up the volume (p. 46).
- Sound is not output when the LCD screen is closed. Open the LCD screen.
- When you record sound with [MICREF LEVEL] (p. 104) set to [LOW], the recorded sound may be difficult to hear.
- Sounds cannot be recorded while recording a 3 second-movie (approx.) using [SMTH SLW REC] (p. 42).

Playing back a disc on other devices

You cannot play back the disc, or the disc is not recognized.

- To play back a disc recorded with HD (high definition) image quality, you need a device compatible with AVCHD format/High Profile (p. 128).
- Clean the disc using a soft cloth (p. 128).
- Finalize the disc (p. 73).
- A disc recorded in VR mode cannot be played back on a device that does not support VR mode. Check the compatibility in the instruction manual of the playback device.

The playback image is distorted.

- Clean the disc using a soft cloth (p. 128).

“?” is indicated on an image in the disc menu/DVD menu.

- Loading of the data may have failed when the disc was finalized. For the following discs, make the disc capable of additional recording (p. 80), then remake the disc menu by finalizing the disc again (p. 75). The disc menu/DVD menu may be displayed correctly.
 - DVD+RW
 - DVD-RW recorded with HD (high definition) image quality
 - DVD-RW (VIDEO mode) recorded with SD (standard definition) image quality

Playback freezes for an instant between the scenes.

- The image may freeze for an instant between scenes depending on the device being used. This is not a malfunction.
- In case of DVD+R DL, the image may freeze for an instant when the recording layer changes. This is not a malfunction.

Playback does not move to the previous scene when you press



- If playback crosses 2 titles made automatically by your camcorder when  is pressed, playback may not move to the previous scene. Select the desired scene from the menu screen. Refer to the instruction manual of the playback device for further information.

When you play back the disc on a computer or other playback devices, the sound balance of left and right channels is not even.

- This may occur when sound recorded with 5.1ch surround is converted to 2ch (normal stereo sound) on a computer or other playback devices (p. 40). This is not a malfunction.

- When you play back the disc on a 2ch stereo device, change the audio conversion system (downmix system). For details, refer to the instruction manual of the playback device.
- When you create a disc using “Picture Motion Browser,” select 2ch for the audio setting.
- When recording movies, set [AUDIO MODE] to [2ch STEREO] on your camcorder (p. 86).



Playing back a “Memory Stick PRO Duo” on other devices

You cannot play back the “Memory Stick PRO Duo,” or the “Memory Stick PRO Duo” is not recognized.

- To play back the “Memory Stick PRO Duo” with HD (high definition) image quality, you need a device compatible with AVCHD format (p. 8, 128)

Editing images on your camcorder

Unable to edit.

- Set the desired media of images for editing or for image quality by touching  (HOME) →  (MANAGE MEDIA) → [MOVIE MEDIA SET] or [PHOTO MEDIA SET] (HDR-UX20) (p. 28).
- You cannot edit the movies recorded on DVD-R/DVD+R DL (p. 16).
- There are no images recorded on the media.
- You cannot edit because of the condition of the image.
- You cannot edit an image protected on another device.
- You cannot dub movies from the disc to the internal memory (HDR-UX20) or the “Memory Stick PRO Duo.”

Movies cannot be added in the Playlist.

- There is no free space in the media.
- To the Playlist on the internal memory (HDR-UX20) or the “Memory Stick PRO Duo,” you can add a maximum of 999 movies with HD (high definition) image quality, or 99 movies with SD (standard definition) image quality. To the Playlist on the disc, you can add a maximum of 999 movies.
- You cannot add still images in the Playlist.
- You cannot add all movies recorded on a disc to a Playlist at once, when the movies are recorded with both the “1920 × 1080/60i” standard and the “1440 × 1080/60i” standard on the disc.

A movie cannot be divided.

- A movie that is too short cannot be divided.
- A movie protected on another device cannot be divided.

An image cannot be deleted.

- Movies cannot be deleted depending on the following.
 - Movies recorded on DVD-R/DVD+R DL
 - Movies with SD (standard definition) image quality other than the most recent movie on DVD-RW with the VIDEO mode
 - Movies with SD (standard definition) image quality other than the most recent movie on DVD+RW
- During Easy Handycam operation, movies on the disc cannot be deleted.
- An image protected on another devices cannot be deleted.

Still images cannot be captured from a movie.

- There is no space on the media to record a still image (p. 59).

Unable to finalize.

- Battery is running out during finalizing. Use the AC Adaptor.
- The disc has already been finalized. In the case of following discs, follow the required procedure to record additional material (p. 80):
 - DVD+RW
 - DVD-RW recorded with HD (high definition) image quality
 - DVD-RW (VIDEO mode) recorded with SD (standard definition) image quality

Unable to perform [UNFINALIZE].

- You cannot perform [UNFINALIZE] on the following discs:
 - DVD-R
 - DVD+R DL
 - DVD+RW recorded with SD (standard definition) image quality
 - DVD-RW (VR mode) recorded with SD (standard definition) image quality

You cannot edit or record additional material on a disc using other devices.

- You may not be able to edit or record additional material on a disc recorded on your camcorder using other devices.

Viewing images on the TV

You cannot view the image or hear the sound on the TV.

- When you are using the component A/V cable, set [COMPONENT] according to the requirements of the connected device (p. 95).
- Only the component plugs of the component A/V cable are connected to the TV. Make sure the red and white plugs are connected (p. 51, 53).
- Images are not output from the HDMI OUT jack, if copyright protection signals are recorded in the images.

Troubleshooting (Continued)

- Only the S VIDEO plug of the A/V connecting cable with S VIDEO (optional) is connected to the TV. Make sure the red and white plugs are connected (p. 53).

The image appears distorted on the 4:3 TV.

- This happens when viewing a image recorded in the 16:9 (wide) mode on a 4:3 TV. Set [TV TYPE] correctly (p. 95) and play back the image.

Black bands appear at the top and bottom of the screen of the 4:3 TV.

- This happens when viewing a image recorded in the 16:9 (wide) mode on a 4:3 TV. This is not a malfunction.

Dubbing to other devices

You cannot dub.

- You cannot dub images using the HDMI cable.
- The A/V connecting cable is not connected properly. Make sure to connect to the input jack of another device (p. 68).

Connecting to a computer

You cannot install “Picture Motion Browser.”

- Check the computer environment required to install “Picture Motion Browser.”
- Install “Picture Motion Browser” in an orderly manner (p. 105).

“Picture Motion Browser” does not work correctly.

- Finish “Picture Motion Browser” and restart your computer.

Your camcorder is not recognized by the computer.

- Install “Picture Motion Browser” (p. 105).
- Disconnect devices from the USB jack of the computer other than the keyboard, mouse, and your camcorder.
- Disconnect the USB cable from the computer and your camcorder, and restart the computer, then connect the computer and your camcorder again in an orderly manner (p. 107).
- Make sure the media check tool of the computer activates. For details on the media check tool, see “PMB Guide.”

Functions that cannot be used simultaneously

The following list shows examples of unworkable combinations of functions and menu items.

Cannot use	Because of following settings
Back light	[SPOT METER], [FIREWORKS], [MANUAL] in [EXPOSURE]
[WIDE SELECT]	[OLD MOVIE]
[AUTO SLW SHUTTR]	[SMTH SLW REC], [D.EFFECT], [SCENE SELECTION], [COLOR SLOW SHTR], [SUPER NIGHTSHOT], [FADER]

Cannot use	Because of following settings
[FACE DETECTION]	[SMTH SLW REC], [FOCUS], [SPOT FOCUS], [EXPOSURE], [SPOT METER], NightShot, [SUPER NIGHTSHOT], [COLOR SLOW SHTR], [WHITE BAL.], [DIGITAL ZOOM], [TWILIGHT]/[TWILIGHT PORT.]/[CANDLE]/[SUNRISE&SUNSET]/[FIREWORKS]/[LANDSCAPE]/[SPOTLIGHT]/[BEACH]/[SNOW] in [SCENE SELECTION], [D.EFFECT], [PICT.EFFECT]
[DISP OUTPUT]	[CTRL FOR HDMI]
[SPOT FOCUS]	[SCENE SELECTION]
[TELE MACRO]	[SCENE SELECTION]
[EXPOSURE]	NightShot, [SUPER NIGHTSHOT]
[SPOT METER]	NightShot, [SUPER NIGHTSHOT]
[SCENE SELECTION]	NightShot, [SUPER NIGHTSHOT], [COLOR SLOW SHTR], [OLD MOVIE], [TELE MACRO], [FADER]
[WHITE BAL.]	NightShot, [SUPER NIGHTSHOT]
[ONE PUSH] in [WHITE BAL.]	[SMTH SLW REC]
[COLOR SLOW SHTR]	NightShot, [D.EFFECT], [SCENE SELECTION], [FADER]

Cannot use	Because of following settings
[SUPER NIGHTSHOT]	[D.EFFECT], [FADER]
[FADER]	[D.EFFECT], [SUPER NIGHTSHOT], [COLOR SLOW SHTR], [CANDLE]/[FIREWORKS] in [SCENE SELECTION],
[D.EFFECT]	[SUPER NIGHTSHOT], [COLOR SLOW SHTR], [FADER], [SCENE SELECTION], [PICT.EFFECT]
[PICT.EFFECT]	[OLD MOVIE]
[MICREF LEVEL]	[BLT-IN ZOOM MIC]

Warning indicators and messages

Self-diagnosis display/Warning indicators

If indicators appear on the LCD screen or in the viewfinder, check the following.

Some symptoms you can fix by yourself. If the problem persists even after you have tried a couple of times, contact your Sony dealer or local authorized Sony service facility.

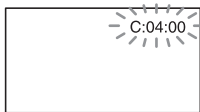

C: (or E:) □□:□□ (Self-diagnosis display)

C:04:□□

- The battery pack is not an “InfoLITHIUM” battery pack (H series). Use an “InfoLITHIUM” battery pack (H series) (p. 130).
- Connect the DC plug of the AC Adaptor to the DC IN jack of your camcorder securely (p. 22).

C:13:□□

- The disc is faulty. Use a compatible disc with your camcorder (p. 16).
- The disc is dirty or has scratches on it. Clean the disc with a soft cloth (p. 128).

C:32:□□

- Symptoms that are not described above have occurred. Remove and insert the disc, then operate your camcorder again.
- Remove the power source. Reconnect it and operate your camcorder again.

E:20:□□ / E:31:□□ / E:61:□□ /

E:62:□□ / E:91:□□ / E:94:□□

- A malfunction that you cannot service has occurred. Contact your Sony dealer or local authorized Sony service facility. Inform them of the 5-digit code, which starts from “E:”

101-0001 (Warning indicator pertaining to files)

Slow flashing

- The file is damaged.
- The file is unreadable.

ⓘ (Warning indicator pertaining to discs)

Slow flashing

- No disc is inserted.*
- Less than 5 minutes remains for recording movies on a disc.
- The disc cannot be read or written, because the single-sided disc is inserted inside out.

Fast flashing

- An unrecognizable disc is inserted.*
- A finalized disc is inserted into your camcorder during recording standby.
- The disc is fully recorded.*
- The disc recorded in the different TV color system from your camcorder is inserted when the  (Movie) lamp lights up.*

▲ (You need to remove the disc)*

Fast flashing

- An unrecognizable disc is inserted.
- The disc is fully recorded.
- An error might have occurred with the disc drive in your camcorder.
- A finalized disc is inserted into your camcorder during recording standby (p. 73).

⚡ (Battery level warning)

Slow flashing

- The battery pack is nearly used up.
- Depending on the operating, environment, or battery conditions, ⚡ may flash, even if there are approximately 20 minutes remaining.

(High temperature warning)

Slow flashing

- The temperature of your camcorder is getting higher. Turn off your camcorder and leave it for a while in a cool place.

Fast flashing*

- The temperature of your camcorder is extremely high. Turn off your camcorder and leave it for a while in a cool place.
-

(Warning indicator pertaining to “Memory Stick PRO Duo”)

Slow flashing

- Free space for recording images are running out. For the type of “Memory Stick” you can use with your camcorder, see page 6.
- No “Memory Stick PRO Duo” is inserted (p. 32).

Fast flashing*

- There are not enough free space for recording images. Delete unnecessary images, or format the “Memory Stick PRO Duo” after saving the images on other media (p. 57, 78, 105).
 - The image database file is damaged (p. 82).
-

(Warning indicators pertaining to “Memory Stick PRO Duo” formatting)*

- The “Memory Stick PRO Duo” is damaged.
 - The “Memory Stick PRO Duo” is not formatted correctly (p. 78, 129).
-

(Warning indicator pertaining to incompatible “Memory Stick PRO Duo”)*

- An incompatible “Memory Stick PRO Duo” is inserted (p. 78, 129).
-

(Warning indicator pertaining to the write-protect of the “Memory Stick PRO Duo”)*

- Access to the “Memory Stick PRO Duo” was restricted on another device.
-

(Warning indicator pertaining to the flash)

Fast flashing

- There is something wrong with the flash.
-

(Warning indicator pertaining to camera-shake warning)

- The amount of lights is not sufficient, so camera-shake easily occurs. Use the flash.
 - The camcorder is unsteady, so camera-shake easily occurs. Hold the camcorder steady with both hands and record the image. However, note that the camera-shake warning indicator does not disappear.
-

(Warning indicator pertaining to recording still images)

- The set media is full.
 - Still images cannot be recorded temporarily because the media is processing other tasks. Try later.
-

* You hear a melody when the warning indicators appear on the screen (p. 93).

Description of warning messages

If messages appear on the screen, follow the instructions.

■ Media

Internal memory format error.

- The format of the internal memory (HDR-UX20) of the camcorder is different from the original format set at the time of purchase. You may be able to use the original format by performing [MEDIA FORMAT] (p. 78). The data of the current format is all deleted.

The Image Database File is damaged. Do you want to create a new file?

HD movie management information is damaged. Create new information?

- The image management file is damaged. When you touch [YES], a new image management file is created. The old recorded images on the “Memory Stick PRO Duo” cannot be played back (Image files are not damaged). If you perform [REPAIR IMG.DB F.] after creating new image management file, playing back the old recorded images may become possible. If it does not work, copy the image to a computer using the supplied software.

Inconsistencies found in Image Database File. Do you want to repair the Image Database File?

The Image Database File is damaged. Do you want to repair the Image Database File?

Inconsistencies found in Image Database File. Cannot record or play HD movies. Do you want to repair the Image Database File?

- You cannot record/play back images because the image database file is damaged. Touch [YES] to repair.

Recording on disc disabled.

- A malfunction has occurred with the disc and the disc cannot be used.

Playback prohibited.

- You are trying to play back an incompatible disc with your camcorder.
- You are trying to play back an image recorded with a copyright protection signal.

Need to unfinalize disc.

- To record on the finalized DVD+RW/DVD-RW (VIDEO mode in the case of SD (standard definition) image quality), unfinalize it (p. 80).

Disc error. Remove disc.

- Your camcorder cannot recognize the disc, because the disc is incompatible, or has scratches.

Disc error. Unsupported format.

- The disc recorded in the different format code from your camcorder. Formatting the disc may enable you to use the disc on your camcorder (DVD-RW/DVD+RW only) (p. 79).

Reinsert the Memory Stick.

- Reinsert the “Memory Stick PRO Duo” a few times. If even then the indicator flashes, the “Memory Stick PRO Duo” could be damaged. Try with another “Memory Stick PRO Duo.”

This Memory Stick is not formatted correctly.

- Check the format, then format the “Memory Stick PRO Duo” with your camcorder if necessary (p. 78, 129).

Memory Stick folders are full.

- You cannot create folders exceeding 999MSDCF. You cannot create or delete created folders using your camcorder.
- Format the “Memory Stick PRO Duo” (p. 78), or delete folders using your computer.

Cannot save still picture.

- When using the Dual Rec function, do not eject the “Memory Stick PRO Duo” from the camcorder until movie recording is finished and the still images are stored on it (p. 41).

This Memory Stick may not be able to record or play movies.

- Use the recommended “Memory Stick” (p. 6).

This Memory Stick may not be able to record or play images correctly.

- An error occurred on “Memory Stick PRO Duo.” Insert the “Memory Stick PRO Duo” again.
- Contact your Sony dealer or local authorized Sony service facility.

Do not eject the Memory Stick during writing. Data may be damaged.

- Insert the “Memory Stick PRO Duo” again, and follow the instructions on the screen.

■ PictBridge compliant printer

Not connected to PictBridge compatible printer.

- Turn off the printer and on again, then disconnect the USB cable and reconnect it.

Cannot print. Check the printer.

- Turn off the printer and on again, then disconnect the USB cable and reconnect it.

■ Others

No further selection is possible.

- To the Playlist on the internal memory (HDR-UXX20) or the “Memory Stick PRO Duo,” you can add a maximum of 999 movies with HD (high definition) image quality, or 99 movies with SD (standard definition) image quality. To the Playlist on the disc, you can add a maximum of 999 movies.
- The maximum number of images that you can select on the INDEX screen at one time is 100 when:
 - delete images
 - dub movies
 - copy still images
 - edit the playlist
 - print still images

Data protected.

- You tried to delete a still image data protected on another device. Release the protection of the data on the device used to protect the data.

Cannot divide.

- You cannot divide a movie that is extremely short.

Cannot recover data.

- Writing data to the media has failed. Attempts were made to recover the data, but they were unsuccessful.

Please wait.

- This is displayed if the disc removal process takes time. Turn on the camcorder and leave it for about 10 minutes, preventing vibration.

Using your camcorder abroad

Power supply

You can use your camcorder in any countries/regions using the AC Adaptor supplied with your camcorder within the AC 100 V to 240 V, 50/60 Hz range. Use a commercially available AC plug adaptor [a], if necessary, depending on the design of the wall outlet [b].

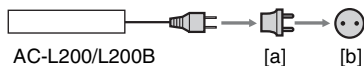

Viewing images recorded with HD (high definition) image quality

In countries/regions where 1080/60i is supported, you can view the images with the same HD (high definition) image quality as that of the recorded images. You need a NTSC-system-based and 1080/60i compatible TV (or monitor) with component and AUDIO/VIDEO input jacks. And the Component A/V cable (supplied) or the HDMI cable (optional) must be connected.

Viewing images recorded with SD (standard definition) image quality

To view images recorded with SD (standard definition) image quality, you need a NTSC-system-based TV with AUDIO/VIDEO input jacks. An A/V connecting cable must be connected.

On TV color systems

Your camcorder is a NTSC-system-based camcorder. If you want to view the playback image on a TV, it must be a NTSC-system-based TV with an AUDIO/VIDEO input jack.

System	Used in
NTSC	Bahama Islands, Bolivia, Canada, Central America, Chile, Colombia, Ecuador, Guyana, Jamaica, Japan, Korea, Mexico, Peru, Surinam, Taiwan, the Philippines, the U.S.A., Venezuela, etc.
	Australia, Austria, Belgium, China, Czech Republic, Denmark, Finland, Germany, Holland, Hong Kong, Hungary, Italy, Kuwait, Malaysia, New Zealand, Norway, Poland, Portugal, Singapore, Slovak Republic, Spain, Sweden, Switzerland, Thailand, United Kingdom, etc.
PAL - M	Brazil
PAL - N	Argentina, Paraguay, Uruguay.
SECAM	Bulgaria, France, Guiana, Iran, Iraq, Monaco, Russia, Ukraine, etc.

Setting to the local time

You can easily set the clock to the local time by setting a time difference when using your camcorder abroad. Touch **HOME** → **SETTINGS** → **[CLOCK/ LANG]** → **[AREA SET]** and **[DST SET]/[SUMMERTIME]** (p. 96).

World time difference

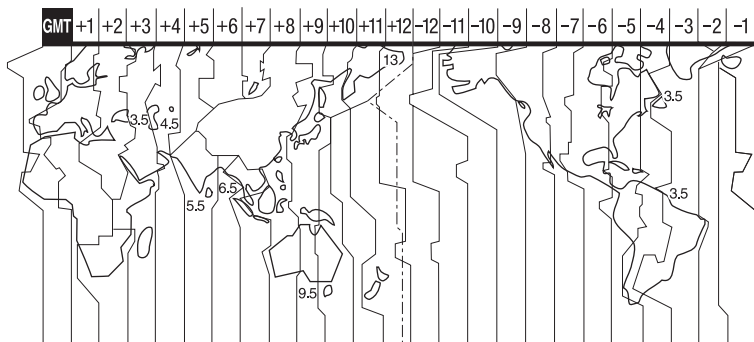

Time-zone differences	Area setting
GMT	Lisbon, London
+01:00	Berlin, Paris
+02:00	Helsinki, Cairo, Istanbul
+03:00	Moscow, Nairobi
+03:30	Tehran
+04:00	Abu Dhabi, Baku
+04:30	Kabul
+05:00	Karachi, Islamabad
+05:30	Calcutta, New Delhi
+06:00	Almaty, Dhaka
+06:30	Rangoon
+07:00	Bangkok, Jakarta
+08:00	HongKong, Singapore, Beijing
+09:00	Seoul, Tokyo
+09:30	Adelaide, Darwin
+10:00	Melbourne, Sydney

Time-zone differences	Area setting
+11:00	Solomon Is.
+12:00	Fiji, Wellington
-12:00	Eniwetok, Kwajalein
-11:00	Midway Is., Samoa
-10:00	Hawaii
-09:00	Alaska
-08:00	Los Angeles, Tijuana
-07:00	Denver, Arizona
-06:00	Chicago, Mexico City
-05:00	New York, Bogota
-04:00	Santiago
-03:30	St. John's
-03:00	Brasilia, Montevideo
-02:00	Fernando de Noronha
-01:00	Azores, Cape Verde Is.

Files/folder structure on the internal memory (HDR-UX20) and a “Memory Stick PRO Duo”

The file/folder structure on the internal memory (HDR-UX20) “Memory Stick PRO Duo” is shown below. You do not usually need to acknowledge the file/folder structure, when recording/playing back images on the camcorder. To enjoy movies or still images by connecting to a computer, see “PMB Guide,” then use the supplied application.

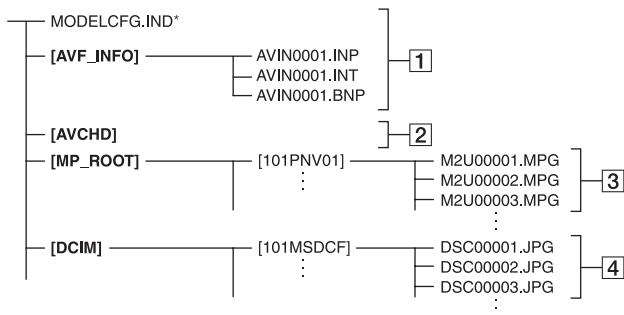

* For the internal memory (HDR-UX20) only.

1 Image management files

When you delete the files, you cannot record/play back the images correctly. The files are defaulted as hidden files and not usually displayed.

2 HD movie management information folder

This folder contains recording data of movies with HD (high definition) image quality. Do not try to open this folder or access the contents of this folder from a computer. Doing so might damage image files, or prevent image files from being played back.

3 SD movie files (MPEG2 files)

The extension of the files is “.MPG”. The maximum size is 2 GB. When the capacity of a file exceeds 2 GB, the file becomes divided. The file numbers go up automatically. When the capacity of a file number exceeds 9999, another folder is created to record new movie files.

The folder name goes up: [101PNV01] → [102PNV01]

4 Still image files (JPEG files)

The extension of the files is “.JPG”. The file numbers go up automatically. When the capacity of a file number exceeds 9999, another folder is created to store new image files.

The folder name goes up: [101MSDCF] → [102MSDCF]

- Connecting with the USB cable (supplied), you can access the media in the camcorder from the computer (p. 105).
- Do not modify the files or folders on the media in the camcorder from the computer. The image files may be destroyed or may not be played back.
- Operation is not guaranteed, if you perform the above operation.
- When you delete image files, follow the steps on page 57. Do not delete the image files on the media in the camcorder directly from the computer.
- Do not format the media in the camcorder using the computer. The camcorder may not operate correctly.
- Do not copy any files to the media in the camcorder from the computer. Operation is not guaranteed.

Precautions and maintenance

About the Disc

See page 16 for the details of discs which you can use with your camcorder.

Notes on use

- Hold the disc by its edge while supporting the center hole lightly. Do not touch the recording side (the opposite of the printed side when using a single-sided disc).



- Before shooting, be sure to remove dust and fingerprints from the disc with a soft cloth. Otherwise you may not be able to record or play normally in some situations using that disc.
- When you set the disc in your camcorder, press firmly until it clicks. When the message [C:13:□□] appears on the LCD screen, open the disc cover and set the disc again.
- Do not attach any adhesive material such as a sticker on the surface of a disc. If you do so, the disc may become unbalanced, and this may cause a malfunction of the disc or your camcorder.



Use of double-sided discs

Double-sided discs allow you to record both sides of a disc.

■ Recording on the A side

Place the disc in your camcorder with the side with the **A** symbol at the center facing outwards until it clicks.

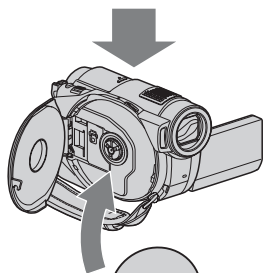
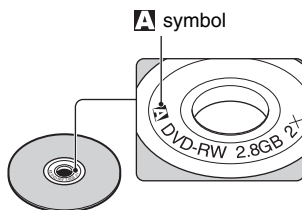

Place the **A** symbol facing outwards.
Recording is made on the rear side.

- When using a double-sided disc, take care not to smudge the surface with fingerprints.
- When a double-sided disc is used in your camcorder, recording/playback are performed on that side only. You cannot switch to record on or play back the other side with the disc set to the camcorder. When recording/playback of one side is complete, remove, then insert it again and turn the disc over to access the other side.
- Perform the following operations on each side of a double-sided disc:
 - Finalizing (p. 73)
 - Formatting (p. 79)
 - Unfinalizing (p. 80)

Precautions and maintenance (Continued)

Care and storage of the discs

- Keep the disc clean, or the image quality of the audio and video output may deteriorate.
- Clean the disc with a soft cloth. Wipe the disc from the center out. For dirt, clean the disc with a soft cloth slightly moistened in water, then remove the moisture with a soft, dry cloth. Do not use solvents such as benzene, cleaners intended for vinyl LPs or antistatic spray, as they may cause a malfunction to the disc.



- Do not expose the disc to direct sunlight or leave it in a humid place.
- When you carry or store the disc, put it in its case.
- When you want to write letters or marks, etc. on a single-sided disc, write only on the printed side using an oil-based marker with a felt-tip, and do not touch the ink until it dries. Do not heat the disc or use a sharp-pointed tool, such as ball point pen. Do not dry the surface by heating. You cannot write, or mark, on double-sided discs.

About the AVCHD format

What is the AVCHD format?

The AVCHD format is a high definition digital video camera format used to record an HD (high definition) signal of either the 1080i specification^{*1} or the 720p specification^{*2}, using efficient data compression coding technology. The MPEG-4 AVC/H.264 format is adopted to compress video data, and the Dolby Digital or Linear PCM system is used to compress audio data.

The MPEG-4 AVC/H.264 format is capable of compressing images at higher efficiency than that of the conventional image compressing format. The MPEG-4 AVC/H.264 format enables a high definition video signal shot on a digital video camera recorder to be recorded on 8 cm DVD discs, etc.

Recording and playback on your camcorder

Based on the AVCHD format, your camcorder records with the HD (high definition) image quality mentioned below.

Video signal:

MPEG-4 AVC/H.264 1920 × 1080/60i,
1440 × 1080/60i

Audio signal:

Dolby Digital 5.1ch, 2ch

Recording media:

Internal memory (HDR-UX20), 8 cm DVD-RW, DVD+RW, DVD-R, DVD+R DL discs, "Memory Stick PRO Duo"

- The media recorded in AVCHD format other than the above mentioned cannot be played on your camcorder. 8 cm DVD-RAM discs cannot be recorded or played on your camcorder.

In addition to HD (high definition) image quality, your camcorder is capable of recording an SD (standard definition) signal on 8 cm DVD discs, etc.

*1: 1080i specification

A high definition specification which utilizes 1080 effective scanning lines and the interlace system.

*2: 720p specification

A high definition specification which utilizes 720 effective scanning lines and the progressive system.

About the “Memory Stick”

A “Memory Stick” is a compact, portable IC recording medium with a large data capacity.

You can use only a “Memory Stick Duo,” which is about the half size of a standard “Memory Stick,” with your camcorder. However, we do not guarantee the operation of all types of “Memory Stick Duo” on your camcorder.

Types of “Memory Stick”	Recording/ Playback
“Memory Stick Duo” (with MagicGate)	–
“Memory Stick PRO Duo”	○
“Memory Stick PRO-HG Duo”	○*

- * This product is not compatible with 8-bit parallel data transfer, but it supports 4-bit parallel data transfer the same as with “Memory Stick PRO Duo.”
- This product cannot record or play data that uses “MagicGate” technology. “MagicGate” is a copyright protection technology that records and transfers the contents in an encrypted format.
- A “Memory Stick PRO Duo” formatted by a computer (Windows OS/Mac OS) does not have guaranteed compatibility with your camcorder.
- Data read/write speed may vary depending on the combination of the “Memory Stick PRO Duo” and “Memory Stick PRO Duo” compliant product you use.
- Damaged or lost data may occur in the following cases (the data will not be compensated for):
 - If you eject the “Memory Stick PRO Duo,” or turn off your camcorder while your camcorder is reading or writing image files on the “Memory Stick PRO Duo” (while the access lamp is lit or flashing).
 - If you use the “Memory Stick PRO Duo” near magnets or magnetic fields.
- It is recommended you make a back-up of important data on the hard disk of a computer.
- Be careful not to apply excessive force when writing on a memo area on a “Memory Stick PRO Duo.”

- Do not attach a label or the like on a “Memory Stick PRO Duo” or a Memory Stick Duo adaptor.
- When you carry or store a “Memory Stick PRO Duo,” put it in its case.
- Do not touch, or allow metallic objects to come into contact with the terminals.
- Do not bend, drop or apply strong force to the “Memory Stick PRO Duo.”
- Do not disassemble or modify the “Memory Stick PRO Duo.”
- Do not let the “Memory Stick PRO Duo” get wet.
- Be careful to keep “Memory Stick PRO Duo” media out of the reach of small children. There is danger that a child might swallow it.
- Do not insert anything other than a “Memory Stick PRO Duo” into the Memory Stick Duo slot. Doing so may cause a malfunction.
- Do not use or keep the “Memory Stick PRO Duo” in the following locations:
 - Places subject to extremely high temperature, such as a car parked outside in the summer.
 - Places under direct sunlight.
 - Places with extremely high humidity or subject to corrosive gases.

■ On the Memory Stick Duo adaptor

- When using a “Memory Stick PRO Duo” with a “Memory Stick” compliant device, be sure to insert the “Memory Stick PRO Duo” into a Memory Stick Duo adaptor.
- When inserting a “Memory Stick PRO Duo” into a Memory Stick Duo adaptor, make sure the “Memory Stick PRO Duo” is inserted facing in the correct direction, then insert it all the way in. Note that improper use may cause a malfunction. Also, if you force the “Memory Stick PRO Duo” into the Memory Stick Duo adaptor in the wrong direction, it may be damaged.
- Do not insert a Memory Stick Duo adaptor without a “Memory Stick PRO Duo” attached. Doing so may result in malfunctions of the unit.

■ On a “Memory Stick PRO Duo”

- Up to 8 GB of “Memory Stick PRO Duo” or “Memory Stick PRO-HG Duo” are confirmed to be able to be used with your camcorder.

On image data compatibility

- Image data files recorded on a “Memory Stick PRO Duo” by your camcorder conform to the “Design rule for Camera File system” universal standard established by the JEITA (Japan Electronics and Information Technology Industries Association).
- On your camcorder, you cannot play back still images recorded on other devices (DCR-TRV900 or DSC-D700/D770) that do not conform to the universal standard. (These models are not sold in some regions.)
- If you cannot use a “Memory Stick PRO Duo” that has been used with another device, format it with your camcorder (p. 78). Note that formatting erases all information on the “Memory Stick PRO Duo.”
- You may not be able to play back images with your camcorder:
 - When playing back image data modified on your computer.
 - When playing back image data recorded with other devices.

About the “InfoLITHIUM” battery pack

Your camcorder operates only with an “InfoLITHIUM” battery pack (H series). “InfoLITHIUM” H series battery packs have the  mark.

What is an “InfoLITHIUM” battery pack?

An “InfoLITHIUM” battery pack is a lithium-ion battery pack that has functions for communicating information related to operating conditions between your camcorder and an optional AC Adaptor/charger.

The “InfoLITHIUM” battery pack calculates the power consumption according to the operating conditions of your camcorder, and displays the remaining battery time in minutes.

With an AC Adaptor/charger, the remaining battery time and charging time appear.

To charge the battery pack

- Be sure to charge the battery pack before you start using your camcorder.
- We recommend charging the battery pack in an ambient temperature of between 10 °C to 30 °C (50 °F to 86 °F) until the CHG (charge) lamp turns off. If you charge the battery pack outside of this temperature range, you may not be able to charge it efficiently.
- After charging is complete, disconnect the cable from the DC IN jack on your camcorder or remove the battery pack.



To use the battery pack effectively

- Battery pack performance decreases when the surrounding temperature is 10 °C (50 °F) or below, and the length of time you can use the battery pack becomes shorter. In that case, do one of the following to use the battery pack for a longer time.
 - Put the battery pack in a pocket to warm it up, and insert it in your camcorder right before you start taking shots.
 - Use a large capacity battery pack: NP-FH70/ NP-FH100 (optional).
- Frequent use of the LCD screen or a frequent playback, fast forward or rewind operation wears out the battery pack faster. We recommend using a large capacity battery pack: NP-FH70/NP-FH100 (optional).
- Be sure to set the POWER switch to OFF (CHG) when not recording or playing back on your camcorder. The battery pack is also consumed when your camcorder is in recording standby or playback pause.
- Have spare battery packs ready for two or three times the expected recording time, and make trial recordings before making the actual recording.
- Do not expose the battery pack to water. The battery pack is not water resistant.

About the remaining battery time indicator

- When the power goes off even though the remaining battery time indicator indicates that the battery pack has enough power to operate, charge the battery pack fully again. Remaining battery time will be indicated correctly. Note, however, that the battery indication will not be restored if it is used in high temperatures for a long time, or if left in a fully charged state, or when the battery pack is frequently used. Use the remaining battery time indication as a rough guide only.
- The  mark that indicates low battery flashes even if there are still 20 minutes of battery time remaining, depending on the operating conditions or ambient temperature.

About storage of the battery pack

- If the battery pack is not used for a long time, fully charge the battery pack and use it up on your camcorder once a year to maintain proper function. To store the battery pack, remove it from your camcorder and put it in a dry, cool place.
- To discharge the battery pack on your camcorder completely, touching  (HOME) →  (SETTINGS) → [GENERAL SET] → [A.SHUT OFF] → [NEVER] and leave your camcorder in recording standby until the power goes off (p. 97).

About battery life

- Battery capacity decreases over time and through repeated use. If decreased usage time between charges becomes significant, it is probably time to replace it with a new one.
- Each battery's life is governed by storage, operating and environmental conditions.

About the x.v.Color

- x.v.Color is a more familiar term for the xVYCC standard proposed by Sony, and is a trademark of Sony.
- xVYCC is an international standard for color space in video. This standard can express a wider color range than the currently used broadcast standard.

About handling of your camcorder

On use and care

- Do not use or store the camcorder and accessories in the following locations:
 - Anywhere extremely hot, cold or humid. Never leave them exposed to temperatures above 60 °C (140 °F), such as under direct sunlight, near heaters or in a car parked in the sun. They may malfunction or become deformed.
 - Near strong magnetic fields or mechanical vibration. The camcorder may malfunction.
 - Near strong radio waves or radiation. The camcorder may not be able to record properly.
 - Near AM receivers and video equipment. Noise may occur.
 - On a sandy beach or anywhere dusty. If sand or dust gets in your camcorder, it may malfunction. Sometimes this malfunction cannot be repaired.
 - Near windows or outdoors, where the LCD screen, the viewfinder, or the lens may be exposed to direct sunlight. This damages the inside of the viewfinder or the LCD screen.
- Operate your camcorder on DC 6.8 V/7.2 V (battery pack) or DC 8.4 V (AC Adaptor).
- For DC or AC operation, use the accessories recommended in these operating instructions.
- Do not let your camcorder get wet, for example, from rain or sea water. If your camcorder gets wet, it may malfunction. Sometimes this malfunction cannot be repaired.
- If any solid object or liquid gets inside the casing, unplug your camcorder and have it checked by a Sony dealer before operating it any further.
- Avoid rough handling, disassembling, modifying, physical shock, or impact such as hammering, dropping or stepping on the product. Be particularly careful of the lens.
- Keep the POWER switch setting to OFF (CHG) when you are not using your camcorder.
- Do not wrap your camcorder with a towel, for example, and operate it. Doing so might cause heat to build up inside.
- When disconnecting the power cord (mains lead), pull it by the plug and not the cord.

Precautions and maintenance (Continued)

- Do not damage the power cord (mains lead) such as by placing anything heavy on it.
- Keep metal contacts clean.
- Keep the Remote Commander and button-type battery out of children's reach. If the battery is accidentally swallowed, consult a doctor immediately.
- If the battery electrolytic liquid has leaked:
 - consult your local authorized Sony service facility.
 - wash off any liquid that may have contacted your skin.
 - if any liquid gets in your eyes, wash with plenty of water and consult a doctor.

■ When not using your camcorder for a long time

- Periodically turn it on and let it run such as by playing back or recording images for about 3 minutes.
- Remove a disc from your camcorder.
- Use up the battery pack completely before storing it.

Moisture condensation

If your camcorder is brought directly from a cold place to a warm place, moisture may condense inside your camcorder, on the surface of the disc, or on the pickup lens. This may cause a malfunction to your camcorder.

■ If moisture condensation has occurred

Leave your camcorder for about 1 hour without turning it on.

■ Note on moisture condensation

Moisture may condense when you bring your camcorder from a cold place into a warm place (or vice versa) or when you use your camcorder in a humid place as follows:

- You bring your camcorder from a ski slope into a place warmed up by a heating device.
- You bring your camcorder from an air conditioned car or room into a hot place outside.
- You use your camcorder after a squall or a shower.
- You use your camcorder in a hot and humid place.

■ How to prevent moisture condensation

When you bring your camcorder from a cold place into a warm place, put your camcorder in a plastic bag and seal it tightly. Remove the bag when the air temperature inside the plastic bag has reached the surrounding temperature (after about 1 hour).

LCD screen



- Do not exert excessive pressure on the LCD screen, as it may cause damage.
- If your camcorder is used in a cold place, a residual image may appear on the LCD screen. This is not a malfunction.
- While using your camcorder, the back of the LCD screen may heat up. This is not a malfunction.

■ To clean the LCD screen

If fingerprints or dust make the LCD screen dirty, it is recommended you use a soft cloth to clean it. When you use the LCD Cleaning Kit (optional), do not apply the cleaning liquid directly to the LCD screen. Use cleaning paper moistened with the liquid.

■ On adjustment of the touch panel (CALIBRATION)

The buttons on the touch panel may not work correctly. If this happens, follow the procedure below. It is recommended that you connect your camcorder to the wall outlet (wall socket) using the supplied AC Adaptor during the operation.

- ① Turn on your camcorder.
- ② Touch  (HOME) →  (SETTINGS) → [GENERAL SET] → [CALIBRATION].

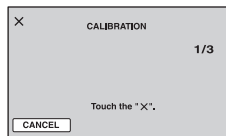

- ③ Touch “x” displayed on the screen with the corner of the “Memory Stick PRO Duo” or the like 3 times. The position of “x” changes.

Touch [CANCEL] to cancel.

If you did not press the right spot, try the calibration again.

🔊 Notes

- Do not use a sharp-pointed object for calibration. Doing so may damage the LCD screen.
- You cannot calibrate the LCD screen if it is rotated, or closed with the screen facing out.

On maintenance of the casing

- If the casing is soiled, clean the camcorder body with a soft cloth lightly moistened with water, and then wipe the casing with a dry soft cloth.
- Avoid the following to avoid damage to the finish:
 - Using chemicals such as thinner, benzene, alcohol, chemical cloths, repellent, insecticide and sunscreen.
 - Handling the camcorder with above substances on your hands.
 - Leaving the casing in contact with rubber or vinyl objects for a long period of time.

On the pickup lens

- Do not touch the pickup lens inside the disc cover. Keep the disc cover closed except when inserting and removing the disc, to keep dust out.
- When your camcorder does not work because the pickup lens is dirty, clean it with a blower (optional). Do not touch the pickup lens directly during cleaning because this may cause the camcorder to malfunction.

Pickup lens

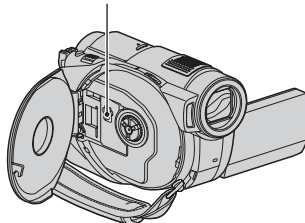

About care and storage of the lens

- Wipe the surface of the lens clean with a soft cloth in the following instances:
 - When there are fingerprints on the lens surface.
 - In hot or humid locations
 - When the lens is exposed to salty air such as at the seaside.
- Store in a well-ventilated location subject to little dirt or dust.
- To prevent mold, periodically clean the lens as described above. It is recommended that you operate your camcorder about once a month to keep it in optimum state for a long time.

About care of the viewfinder

To remove dust from inside the viewfinder, follow the procedure below.

- ① Pull out the viewfinder.
- ② While pushing in the tab on the bottom of the viewfinder with a fine-tipped implement such as a ball point pen, pull the eyecup block in the direction of the arrow to remove.

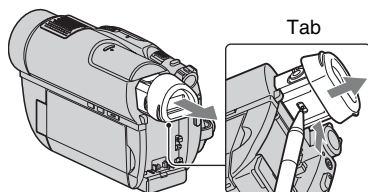

Precautions and maintenance (Continued)

- ③ Remove dust from the eyecup block with a camera blower, etc.

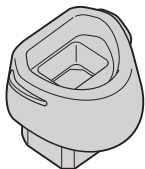

- ④ Press the viewfinder back onto the body of the camcorder.
- ⑤ Remove dust from the inside area where the eyecup block was attached with a camera blower, etc.

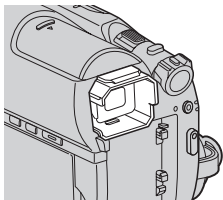

- ⑥ Attach the eyecup block to the viewfinder, pushing it straight on until it clicks.

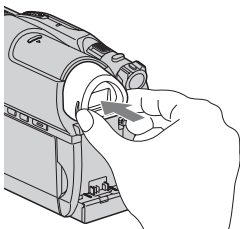

⚡ Notes

- The eyecup block is a precision part. Do not disassemble it further.
- Do not touch the lens of the eyecup block.

On charging the pre-installed rechargeable battery

Your camcorder has a pre-installed rechargeable battery to retain the date, time, and other settings even when the POWER switch is set to OFF (CHG). The pre-installed rechargeable battery is always charged while your camcorder is connected to the wall outlet (wall socket) via the AC Adaptor or while the battery pack is attached. The rechargeable battery will be fully discharged in about **3 months** if you do not use your camcorder at all. Use your camcorder after charging the pre-installed rechargeable battery.

However, even if the pre-installed rechargeable battery is not charged, the camcorder operation will not be affected as long as you are not recording the date.

■ Procedures

Connect your camcorder to a wall outlet (wall socket) using the supplied AC Adaptor, and leave it with the POWER switch set to OFF (CHG) for more than 24 hours.

Specifications

System

Video compression format

AVCHD (HD)/MPEG2 (SD)/JPEG
(Still images)

Audio compression format

Dolby Digital 2/5.1ch
Dolby Digital 5.1 Creator

Video signal

NTSC color, EIA standards
1080/60i specification

Internal memory (HDR-UX20)

8 GB
When measuring media capacity, 1 GB equals 1 billion bytes, a portion of which is used for data management.

Usable discs

8 cm DVD-RW/DVD+RW/DVD-R/
DVD+R DL

Movie recording format

HD:

AVCHD 1080/60i

SD:

Internal memory, "Memory Stick
PRO Duo":
MPEG2-PS

Disc:

DVD-RW: DVD-VIDEO (VIDEO
mode), DVD-Video Recording (VR
mode)

DVD+RW: DVD+RW Video

DVD-R/DVD+R DL: DVD-VIDEO

Still image recording format

Exif Ver.2.2*

Viewfinder

Electric viewfinder (color)

Image device

3.6 mm (1/5 type) CMOS Sensor
Recording pixels (still, 4:3):
Max. 4.0 mega (2 304 × 1 728) pixels**
Gross: Approx. 2 360 000 pixels
Effective (movie, 16:9):
1 490 000 pixels

Effective (still, 16:9):

1 490 000 pixels

Effective (still, 4:3):

1 990 000 pixels

Lens

Carl Zeiss Vario-Sonnar T*

15 × (Optical)

30 ×, 180 × (Digital)

Filter diameter: 30 mm (1 3/16 in.)

Focal length

F1.8 - 2.6

f=3.1 - 46.5 mm (1/8 - 1 7/8 in.)

When converted to a 35 mm still
camera

For movies: 40 - 600 mm

(1 5/8 - 23 5/8 in.) (16:9)

For still images: 37 - 555 mm

(1 1/2 - 21 7/8 in.) (4:3)

Color temperature

[AUTO], [ONE PUSH],

[INDOOR] (3 200 K),

[OUTDOOR] (5 800 K)

Minimum illumination

5 lx (lux) ([AUTO SLW SHUTTR] to
[ON], Shutter speed 1/30 sec.)

0 lx (lux) (during NightShot function)

* "Exif" is a file format for still images, established by the JEITA (Japan Electronics and Information Technology Industries Association). Files in this format can have additional information such as your camcorder's setting information at the time of recording.

** The unique pixel array of Sony's ClearVid CMOS Sensor and image processing system (BIONZ) allows the still image resolution equivalent to the sizes described.

Specifications (Continued)

Input/Output connectors

A/V Remote connector

Component/video and audio output jack

HDMI OUT jack

HDMI Type C mini connector

USB jack

mini-B

LCD screen

Image

6.7 cm (2.7 type, aspect ratio 16:9)

Total dot number

211 200 (960 × 220)

General

Power requirements

DC 6.8 V/7.2 V (battery pack)

DC 8.4 V (AC Adaptor)

Average power consumption

During camera recording using the viewfinder with normal brightness:

HDR-UX10:

HD: 4.7 W, SD: 3.7 W

HDR-UX20:

HD: 4.2 W, SD: 3.3 W

During camera recording using the LCD screen with normal brightness:

HDR-UX10:

HD: 5.0 W, SD: 4.0 W

HDR-UX20:

HD: 4.4 W, SD: 3.5 W

Operating temperature

0 °C to +40 °C (32 °F to 104 °F)

Storage temperature

-20 °C to +60 °C (-4 °F to +140 °F)

Dimensions (approx.)

58 × 93 × 134 mm

(2 3/8 × 3 3/4 × 5 3/8 in.) (w/h/d)

including the projecting parts

58 × 93 × 150 mm

(2 3/8 × 3 3/4 × 6 in.) (w/h/d)

including the projecting parts, the NP-FH60 rechargeable battery pack attached

Mass (approx.)

HDR-UX10:

470 g (1 lb) main unit only

560 g (1 lb 3 oz) including the NP-

FH60 rechargeable battery pack and a disc

HDR-UX20:

470 g (1 lb) main unit only

550 g (1 lb 3 oz) including the NP-

FH60 rechargeable battery pack

Supplied accessories

See page 21.

AC Adaptor AC-L200/L200B

Power requirements

AC 100 V - 240 V, 50/60 Hz

Current consumption

0.35 - 0.18 A

Power consumption

18 W

Output voltage

DC 8.4 V*

Operating temperature

0 °C to +40 °C (32 °F to 104 °F)

Storage temperature

-20 °C to +60 °C (-4 °F to +140 °F)

Dimensions (approx.)

48 × 29 × 81 mm (1 15/16 × 1 3/16 ×

3 1/4 in.) (w/h/d) excluding the projecting parts

Mass (approx.)

170 g (6 oz) excluding the power cord (mains lead)

* See the label on the AC Adaptor for other specifications.

Rechargeable battery pack NP-FH60

Maximum output voltage

DC 8.4 V

Output voltage

DC 7.2 V

Capacity

7.2 Wh (1 000 mAh)



Type

Li-ion

Design and specifications are subject to change without notice.

- Your camcorder is produced under the license of Dolby Laboratories.

On trademarks

- “Handycam” and  are registered trademarks of Sony Corporation.
- “AVCHD” and “AVCHD” logotype are trademarks of Matsushita Electric Industrial Co., Ltd. and Sony Corporation.
- “Memory Stick,”  “Memory Stick Duo,” “MEMORY STICK DUO,” “Memory Stick PRO Duo,” “MEMORY STICK PRO DUO,” “Memory Stick PRO-HG Duo,” “MEMORY STICK PRO-HG DUO,” “MagicGate,” “MAGICGATE,” “MagicGate Memory Stick” and “MagicGate Memory Stick Duo” are trademarks of Sony Corporation.
- “InfoLITHIUM” is a trademark of Sony Corporation.
- DVD-RW, DVD+RW, DVD-R, and DVD+R DL logo are trademarks.
- “x.v.Color” is a trademark of Sony Corporation.
- “BIONZ” is a trademark of Sony Corporation.
- “BRAVIA” is a trademark of Sony Corporation.
- Dolby and the double-D symbol are trademarks of Dolby Laboratories.
- Dolby Digital 5.1 Creator is a trademark of Dolby Laboratories.
- HDMI, the HDMI logo and High-Definition Multimedia Interface are trademarks or registered trademarks of HDMI Licensing LLC.
- Microsoft, Windows, Windows Media, Windows Vista and DirectX are either registered trademarks or trademarks of Microsoft Corporation in the United States and/or other countries.
- Macintosh and Mac OS are registered trademarks of Apple Inc. in the U.S. and other countries.
- Intel, Intel Core and Pentium are trademarks or registered trademarks of Intel Corporation or its subsidiaries in the United States and other countries.
- Adobe, the Adobe logo, and Adobe Acrobat are either registered trademarks or trademarks of Adobe Systems Incorporated in the United States and/or other countries.

All other product names mentioned herein may be the trademarks or registered trademarks of their respective companies. Furthermore, ™ and “®” are not mentioned in each case in this manual.

Notes on the License

ANY USE OF THIS PRODUCT OTHER THAN CONSUMER PERSONAL USE IN ANY MANNER THAT COMPLIES WITH THE MPEG-2 STANDARD FOR ENCODING VIDEO INFORMATION FOR PACKAGED MEDIA IS EXPRESSLY PROHIBITED WITHOUT A LICENSE UNDER APPLICABLE PATENTS IN THE MPEG-2 PATENT PORTFOLIO, WHICH LICENSE IS AVAILABLE FROM MPEG LA, L.L.C., 250 STEELE STREET, SUITE 300, DENVER, COLORADO 80206.

THIS PRODUCT IS LICENSED UNDER THE AVC PATENT PORTFOLIO LICENSE FOR THE PERSONAL AND NON-COMMERCIAL USE OF A CONSUMER TO

(i) ENCODE VIDEO IN COMPLIANCE WITH THE AVC STANDARD ("AVC VIDEO") AND / OR

(ii) DECODE AVC VIDEO THAT WAS ENCODED BY A CONSUMER ENGAGED IN A PERSONAL AND NON-COMMERCIAL ACTIVITY AND/OR WAS OBTAINED FROM A VIDEO PROVIDER LICENSED TO PROVIDE AVC VIDEO. NO LICENSE IS GRANTED OR SHALL BE IMPLIED FOR ANY OTHER USE. ADDITIONAL INFORMATION MAY BE OBTAINED FROM MPEG LA, L.L.C. SEE <[HTTP://MPEGLA.COM](http://MPEGLA.COM)>

"C Library," "Expat," "zlib," and "libjpeg" software are provided in your camcorder. We provide this software based on license agreements with their owners of copyright. Based on requests by the owners of copyright of these software applications, we have an obligation to inform you of the following. Please read the following sections.

Read "license1.pdf" in the "License" folder on the CD-ROM. You will find licenses (in English) of "C Library," "Expat," "zlib," and "libjpeg" software.

On GNU GPL/LGPL applied software

The software that is eligible for the following GNU General Public License (hereinafter referred to as "GPL") or GNU Lesser General Public License (hereinafter referred to as "LGPL") are included in the camcorder.

This informs you that you have a right to have access to, modify, and redistribute source code for these software programs under the conditions of the supplied GPL/LGPL.

Source code is provided on the web. Use the following URL to download it. When downloading the source code, select DCR-DVD810 as the model for your camcorder.

<http://www.sony.net/Products/Linux/>

We would prefer you do not contact us about the contents of source code.



Read "license2.pdf" in the "License" folder on the CD-ROM. You will find licenses (in English) of "GPL," and "LGPL" software.

To view the PDF, Adobe Reader is needed. If it is not installed on your computer, you can download it from the Adobe Systems web page: <http://www.adobe.com/>

Identifying parts and controls

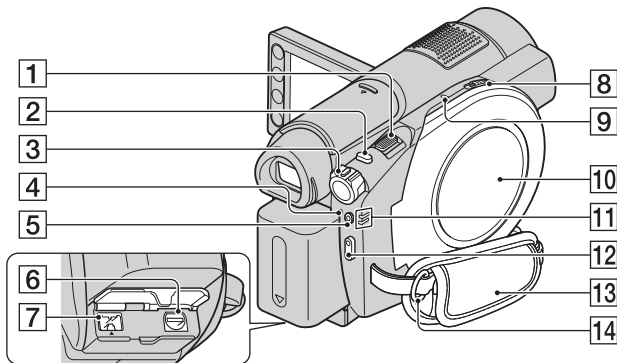
The numbers in () are reference pages.



- 1** Power zoom lever (40, 48)
- 2** PHOTO button (34, 39)
- 3** POWER switch (25)
- 4**  /CHG (flash/charge) lamp (22, 88)
- 5** QUICK ON button (41)
- 6** A/V Remote connector (50, 68)
- 7** DC IN jack (22)
- 8** Disc cover OPEN switch (30)
- 9** ACCESS lamp (30)
The ACCESS lamp lights up when accessing the disc.
- 10** Disc cover (30)
- 11**  (Movie)/  (Still) mode lamps (25)
- 12** START/STOP button (34, 39)
- 13** Grip belt (27)
- 14** Hooks for a shoulder belt
Attach a shoulder belt (optional).

Identifying parts and controls (Continued)

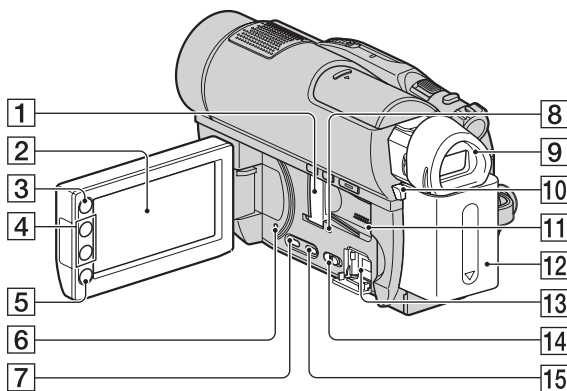

1 Memory Stick Duo slot/Memory Stick Duo slot cover (32)

2 LCD screen/touch panel (18, 27)

3  (HOME) button (18, 84)

4 Zoom buttons (40, 48)

5 START/STOP button (34, 39)

6 RESET button
Initializes all the settings, including the setting of the date and time.

7 DISP/BATT INFO button (23, 27)

8 Access lamp (32)
The access lamp lights up when accessing the internal memory* or “Memory Stick PRO Duo.”

9 Viewfinder (27)

10 BATT (battery release) button (23)

11 Speaker
Playback sounds come out from the speaker. For how to adjust the volume, see page 46.

12 Battery pack (22)

13  (USB) jack (69, 70, 107)

14 NIGHTSHOT switch (41)

15 DUBBING button* (61)

* HDR-UX20

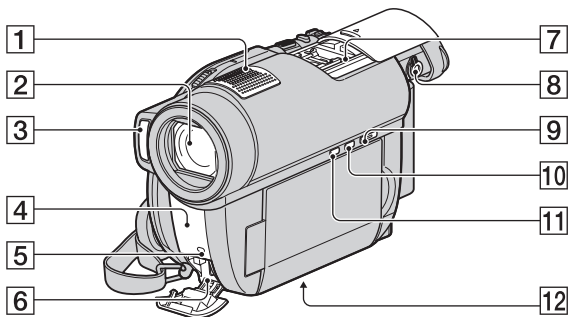

1 Built-in microphone (40)

An Active Interface Shoe compatible microphone (optional) will take precedence when connected.

2 Lens (Carl Zeiss Lens)

3 Flash (88)

4 Infrared port/Remote sensor

Point the Remote Commander (p. 142) towards the remote sensor to operate your camcorder.

5 Camera recording lamp (96)

Lights up in red during recording. Flashes when remaining media space or battery power is low.

6 HDMI OUT jack (50)

7 Active Interface Shoe Active Interface Shoe

The Active Interface Shoe supplies power to optional accessories such as a video light, a flash, or a microphone. The accessory can be turned on or off as you operate the POWER switch on your camcorder. Refer to the operating instructions supplied with your accessory for details.

The Active Interface Shoe has a safety device for fixing the installed accessory securely. To connect an accessory, press down and push it to the end, and then tighten the screw. To remove an accessory, loosen the screw, and then press down and pull out the accessory.

- When you are recording movies with an external flash (optional) connected to the accessory shoe, turn off the power of the external flash to prevent charging noise being recorded.

- You cannot use an external flash (optional) and the built-in flash at the same time.

- When an external microphone (optional) is connected, it takes precedence over the internal microphone (p. 40).

- Slide the shoe cover after pulling out the viewfinder.

8 Viewfinder lens adjustment lever (27)

9 (VIEW IMAGES) button (34, 44)

10 EASY button (34)

11 (back light) button (42)

12 Tripod receptacle

Attach the tripod (optional: the length of the screw must be less than 5.5 mm (7/32 in.)) to the tripod receptacle using a tripod screw.

Remote Commander

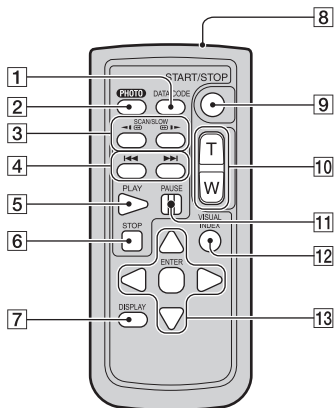

- 1** DATA CODE button (92)
Displays the date and time or camera setting data of the recorded images when you press this during playback.
- 2** PHOTO button (39)
The on-screen image when you press this button will be recorded as a still image.
- 3** SCAN/SLOW buttons (45, 46)
- 4** ◀◀ ▶▶ (Previous/Next) buttons (36, 45, 46)
- 5** PLAY button (36, 45)
- 6** STOP button (36, 45)
- 7** DISPLAY button (27)
- 8** Transmitter
- 9** START/STOP button (39)
- 10** Power zoom buttons (40, 48)
- 11** PAUSE buttons (45)
- 12** VISUAL INDEX button (44)
Displays a VISUAL INDEX screen when you press this during playback.
- 13** ◀ / ▶ / ▲ / ▼ / ENTER buttons
When you press any button on the VISUAL INDEX/Film Roll Index/Face Index screen or Playlist, the orange frame appears on the LCD screen. Select a desired button or an item with ◀ / ▶ / ▲ / ▼, then press ENTER to enter.

Notes

- Remove the insulation sheet before using the Remote Commander.

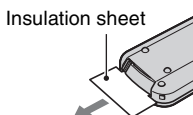

- Point the Remote Commander towards the remote sensor to operate your camcorder (p. 141).
- When no commands have been sent from the Remote Commander in a certain period, the orange frame disappears. When you press any of ◀ / ▶ / ▲ / ▼, or ENTER again, the frame appears at the position where it was displayed last.
- You cannot select some buttons on the LCD screen using ◀ / ▶ / ▲ / ▼.

To change the battery of the Remote Commander

- ① While pressing on the tab, inset your fingernail into the slit to pull out the battery case.
- ② Place a new battery with the + side facing up.
- ③ Insert the battery case back into the Remote Commander until it clicks.

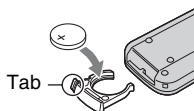

WARNING

Battery may explode if mistreated. Do not recharge, disassemble or dispose of in fire.

- When the lithium battery becomes weak, the operating distance of the Remote Commander may shorten, or the Remote Commander may not function properly. In this case, replace the battery with a Sony CR2025 lithium battery. Use of another battery may present a risk of fire or explosion.

Indicators displayed during recording/playback

Recording movies

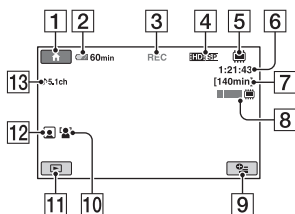

Recording still images

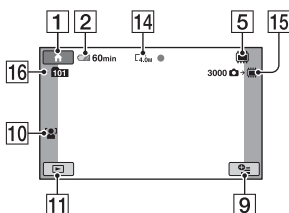

Viewing movies

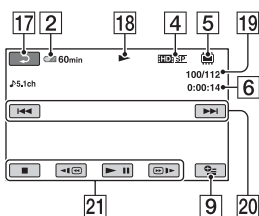

Viewing still images

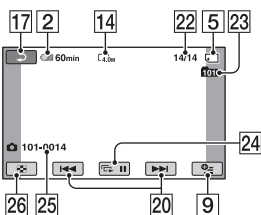

- 1 HOME button (18)
- 2 Remaining battery (approx.) (23)
- 3 Recording status ([STBY] (standby) or [REC] (recording))
- 4 Recording format (HD/SD) and recording mode (FH/FS/HQ/SP/LP) (86)
- 5 Media setting (28)
- 6 Counter (hour/minute/second)
- 7 Remaining recordable time of movies (88)
- 8 Dual Rec (41)
- 9 OPTION button (98)
- 10 FACE DETECTION (89)
- 11 VIEW IMAGES button (44)
- 12 Face Index set (89)
- 13 AUDIO MODE (86)
- 14 Image size (90)
- 15 Remaining recordable number of still images
- 16 Recording folder
When [PHOTO MEDIA SET] is set to the "Memory Stick PRO Duo."
- 17 Return button
- 18 Playback mode
- 19 Currently playing movie number /
Number of total recorded movies
When [MOVIE MEDIA SET] is set to the internal memory (HDR-UX20) or the "Memory Stick PRO Duo."
- 20 Previous/Next button (45, 46)
- 21 Video operation buttons (45)
- 22 Currently playing still image number /
Number of total recorded still images
- 23 Playback folder
When [PHOTO MEDIA SET] is set to the "Memory Stick PRO Duo."
- 24 Slide show button (49)
- 25 Data file name / Scene number

Indicators displayed during recording/playback (Continued)

26 VISUAL INDEX button (44)

Indicators when you made changes

Following indicators appear during recording/playback to indicate the settings of your camcorder.

Upper left Center Upper right

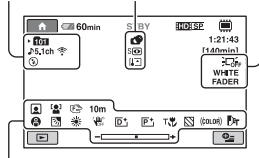

Bottom

Upper left

Indicator	Meaning
	AUDIO MODE (86)
	Self-timer recording (104)
	Flash light (88, 89)
	MICREF LEVEL low (104)
	WIDE SELECT (87)
	BLT-IN ZOOM MIC (104)

Upper right

Indicator	Meaning
	Fader (103)
	LCD backlight off (27)

Center

Indicator	Meaning
	NightShot (41)
	Super NightShot (103)
	Color Slow Shutter (103)
	PictBridge connecting (70)

Indicator	Meaning
	Warning (120)

Bottom

Indicator	Meaning
	Face Index (89)
	FACE DETECTION(89)
	Manual focus (100)
	SCENE SELECTION (101)
	Back light (42)
	White balance (102)
	SteadyShot off (87)
	Digital effect (104)
	Picture effect (104)
	Tele macro (100)
	Zebra (88)
	X.V.COLOR (87)
	CONVERSION LENS (90)
	SPOT METER (101)/EXPOSURE (101)

Notes

- Indicators and their positions are approximate and differ from what you actually see depending on your camcorder model.

Data code during recording

The date, time, and camera setting data of the recorded images are recorded automatically on the media. They are not displayed while recording. However, you can check them as [DATA CODE] during playback (p. 92).

You can view the recording date and time on another device, etc. ([SUB-T DATE], p. 88).

Glossary

■ 5.1ch surround sound

A system that plays back sound on 6 speakers, 3 at the front (left, right and center) and 2 at the rear (right and left) with an additional low-pass subwoofer counted as a 0.1 channel for frequencies of 120 Hz or lower.

■ AVCHD format

A high definition digital video camera format used to record an HD (high definition) signal using the MPEG-4 AVC/H.264 format.

■ Dolby Digital

An audio encoding (compression) system developed by Dolby Laboratories Inc.

■ Dolby Digital 5.1 Creator

Sound compression technology developed by Dolby Laboratories Inc. which compresses audio efficiently while preserving high sound quality. Sounds are compressed effectively with high quality sound, and it enables producing 5.1ch surround sound.

■ DVD format

A format used to record an SD (standard definition) signal on 8 cm DVD discs.

■ JPEG

JPEG stands for Joint Photographic Experts Group, a still image data compression (data capacity reduction) standard. Your camcorder records still images in JPEG format.

■ MPEG

MPEG stands for Moving Picture Experts Group, the group of standards for the coding (image compression) of video (movie) and audio. There are MPEG1 and MPEG2 formats. Your camcorder records movies with SD (standard definition) image quality in MPEG2 format.

■ MPEG-4 AVC/H.264

The latest image coding format standardized jointly by two international standardization organizations, the ISO-IEC and the ITU-T, in 2003. Compared with the conventional MPEG2 format, MPEG-4 AVC/H.264 has more than twice the efficiency. Your camcorder employs MPEG-4 AVC/H.264 to encode high definition movies.

■ Thumbnail

Reduced-size images which enable you to view many images at the same time. The VISUAL INDEX screen, the Film Roll Index screen and the Face Index screen use a thumbnail display system.

■ VIDEO mode

One of the recording formats you can select when using a DVD-RW with SD (standard definition) image quality. VIDEO mode provides excellent compatibility with other DVD devices.

■ VBR

VBR stands for Variable Bit Rate, the recording format for automatically controlling the bit rate (the volume of recording data in a given time segment) according to the scene being recorded. For fast-moving video, a lot of media space is used to produce a clear image, so the recording time to the media shortens.

■ VR mode

One of the recording formats you can select when using a DVD-RW with SD (standard definition) image quality. VR mode enables editing (deleting or sequence rearrangement) with your camcorder. Finalizing the disc lets you play it back on a VR mode compatible DVD device.

Index

Numeric

1080i/480i.....	95
1440 × 1080/60i.....	17, 128
16:9.....	95
16:9 WIDE.....	87
1920 × 1080/60i.....	17, 128
480i.....	95
4:3.....	87, 95
4:3 TV.....	52
5.1ch surround recording.....	40
5.1-channel surround sound	40
8 cm disc.....	16

A

AC Adaptor.....	22
AREA SET.....	96
Aspect ratio.....	52
AUDIO MODE.....	86
AUTO SLW SHUTTR (Auto Slow Shutter).....	87, 118
AVCHD format.....	128, 145
A.SHUT OFF (Auto shut off)	97
A/V connecting cable	21, 53, 68
A/V Remote connector.....	50

B

Back light.....	42, 118
BACKUP.....	62
Battery pack.....	22
BEACH.....	102
BEEP.....	93
BLACK FADER.....	104
BLT-IN ZOOM MIC.....	104
“BRAVIA” Sync.....	54
Button-type lithium battery	142
B&W (black and white).....	104

C

CALIBRATION.....	132
CAMERA DATA.....	92
CANDLE.....	101
CD-ROM.....	105
Charging the battery.....	22
Charging time.....	23
CLOCK SET.....	25
CLOCK/LANG.....	96
COLOR SLOW SHTR (Color Slow Shutter).....	103, 114, 119
COMPONENT.....	95
Component A/V cable	21, 51, 53
Computer.....	105
Connection	
4:3 TV.....	52
High definition TV.....	51
Printer.....	70
VCR/DVD/HDD devices	68
Wide TV.....	52
CONVERSION LENS.....	90
Copy.....	63
CTRL FOR HDMI.....	97

D

DATA CODE.....	92
Date Index.....	48
DATE/TIME.....	25, 92, 144
DC IN jack.....	22
Deleting.....	57
Movie.....	57
Still image.....	58
DEMO MODE.....	96
DIGITAL ZOOM.....	87
Disc.....	28, 30
Disc menu.....	75
DISC SELECT GUIDE.....	81
DISP OUTPUT.....	95, 119
DISPLAY.....	93

DIVIDE.....	64, 97
Dolby Digital 5.1 Creator	40, 145
Double-sided disc.....	127
DST SET.....	96
Dual Rec.....	41
Dubbing	
to a disc on the camcorder	61
to a other devices.....	68
DVD drive.....	77
DVD format.....	16, 145
DVD menu.....	75
DVD-R.....	16
DVD-RW.....	16
DVD+R DL.....	16
DVD+RW.....	16
D.EFFECT (Digital effect)	104, 119

E

Easy Handycam.....	34
Editing.....	56
EMPTY (Data empty).....	83
EXPOSURE.....	101, 119

F

FACE DETECTION.....	89, 119
Face Index.....	47
Face INDEX SET.....	89
FADER.....	103, 119
FH.....	86
FILE NO. (File number).....	91
File/Folder.....	126
Film Roll Index.....	47
Finalize.....	37, 73, 117
FIREWORKS.....	101
FLASH LEVEL.....	89
FLASH MODE.....	88
FOCUS.....	100, 114
Formatting.....	78

FS86

G

GENERAL SET96

Grip belt27

GUIDEFRAAME88

H

HD (high definition) image
quality16, 17, 33, 86

HDMI cable52

Help19

High definition TV51

High Profile8, 115

HOME MENU18, 84

CLOCK/LANG96

GENERAL SET96

MOVIE SETTINGS86

OUTPUT SETTINGS95

PHOTO SETTINGS90

SETTINGS category84

SOUND/DISP SET93

VIEW IMAGES SET92

HQ86

I

IMAGE SIZE90

Indicators143, 144

INDOOR102

“InfoLITHIUM” battery pack
.....130

Install105

Insulation sheet142

Internal memory28

J

JPEG126, 145

L

LANDSCAPE102

LANGUAGE SET96

LAST SCENE DEL (Last
Scene Delete)58

LCD BL LEVEL (LCD back
light level)94, 114

LCD BRIGHT93

LCD COLOR94

LCD panel27

Lens cover38

LP86

M

Maintenance127

MANAGE MEDIA category
.....72

“Memory Stick”28, 129

“Memory Stick PRO Duo”
.....32, 129

MICREF LEVEL104, 119

Mirror mode42

Moisture condensation132

Movie
Recording34, 39

Recording mode86

MOVIE DUB61

MOVIE MEDIA SET28

MOVIE SETTINGS86

MPEG126, 145

MPEG-4 AVC/H.264145

N

NightShot41

NIGHTSHOT LIGHT86

NTSC124

Number of recordable still
images91

O

OLD MOVIE104

ONE PUSH102, 119

OPTION MENU20, 98

Original64, 65

OTHERS category56

OUTDOOR102

OUTPUT SETTINGS95

P

PASTEL104

PB zoom48

PHOTO CAPTURE59

PHOTO COPY63

PHOTO MEDIA SET29

PHOTO SETTINGS90

Pickup lens30, 133

PictBridge70

Picture Motion Browser105

PICT.EFFECT (Picture effect)
.....104, 119

Playback35, 44

Playback time24

Playlist65

PLAYLIST EDIT65

PMB Guide105

PORTRAIT (Soft portrait)
.....102

Power cord (Mains lead)22

Preparation21

Print70

Protect123

Q

QUICK ON41

QUICK ON STBY97

R

REC LAMP (Recording lamp)
.....96

REC MODE86

Recording34, 38, 39

Recording format31, 80

Recording time17, 23, 33

REDEYE REDUC89

Remaining Battery23

REMAINING SET (Movie
remaining set)88

Index (Continued)

Remote Commander... 110, 142
REMOTE CTRL (Remote control)97
REPAIR IMG.DB F.82
RESET.....91, 140

S

SCENE SELECTION. 101, 119
SD (standard definition) image quality 16, 17, 33, 86
Self-diagnosis display..... 120
SELF-TIMER104
SEPIA104
SETTINGS category84
Slide show49
SMTH SLW REC (Smooth Slow Recording).....42
SNOW102
SOUND SETTINGS93
SOUND/DISP SET93
SP86
Specifications 135
SPOT FOCUS 100, 119
SPOT METER (Flexible spot meter)..... 101, 119
SPOTLIGHT102
STEADYSHOT.....87, 114
Still image
 Copying63
 IMAGE SIZE90
SUB-T DATE.....88
SUMMERTIME96
SUNRISE&SUNSET 101
SUPER NIGHTSHOT
..... 103, 114, 119

T

TELE MACRO..... 100, 119
Tripod 141
TV color system 124
TV CONNECT Guide50
TV TYPE.....95

TWILIGHT 101
TWILIGHT PORT..... 101

U

Unfinalizing 80, 117
USB 2.0..... 105
USB connect 69, 70, 107
Using abroad 124

V

VBR 17, 145
VF B.LIGHT (Viewfinder brightness)..... 94
VIDEO mode 31, 145
VIEW IMAGES SET..... 92
Viewfinder lens adjustment lever 27
Viewing images on a TV 49
VISUAL INDEX 35, 44
VOLUME 93
VR mode 31, 145

W

Warning indicators 120
Warning messages 121
WHITE BAL. (White balance) 102, 119
WHITE FADER 104
WIDE SELECT 87, 118
Wide TV 52
Windows 105
World time difference 125

X

X.V.COLOR 87, 131

Z

ZEBRA 88
Zoom..... 40
ZOOM LINK 93

Paso 1: Comprobación de los componentes suministrados

Asegúrese de que dispone de los siguientes componentes suministrados con su videocámara.

El número entre paréntesis indica el número de componentes suministrados.

Adaptador de alimentación de ca (1)

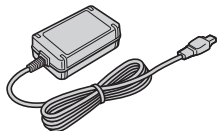

Cable de alimentación (1)



Cable de A/V de componente (1)

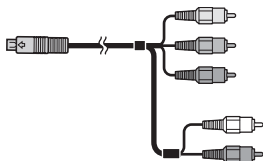

Cable de conexión de A/V (1)



Cable USB (1)

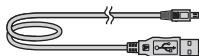

Control remoto inalámbrico (1)



La pila de litio tipo botón ya viene instalada.

Batería recargable NP-FH60 (1)

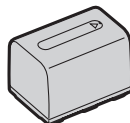

CD-ROM "Handycam Application Software" (1)

- Picture Motion Browser (Software)
- Guía de PMB

"Guía de operaciones" (este manual) (1)

Paso 2: Carga de la batería

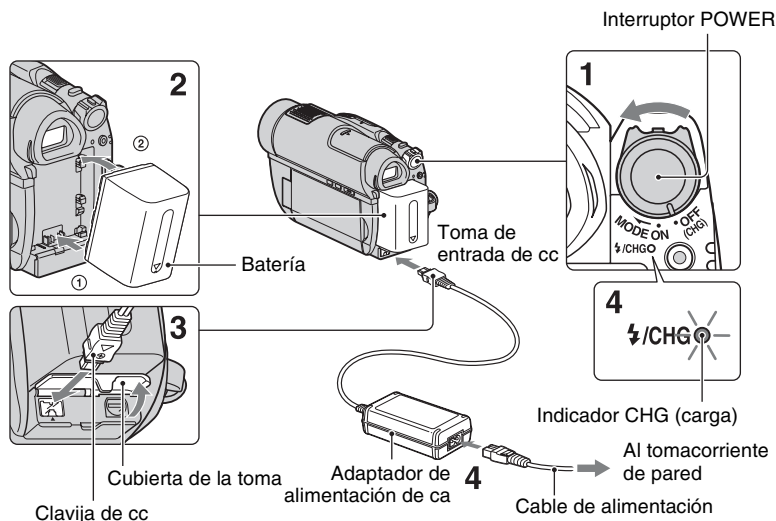

Puede cargar la batería "InfoLITHIUM" (serie H) tras conectarla a la videocámara.

🔌 Notas

- No puede instalar ninguna batería "InfoLITHIUM" que no sea de la serie H a la videocámara.

1 Deslice el interruptor POWER en el sentido de la flecha hacia la posición OFF (CHG) (ajuste predeterminado).

2 Alinee los terminales de la batería y la videocámara (1) y, a continuación, coloque la batería en el sentido de la flecha hasta que haga clic (2).

3 Conecte el adaptador de alimentación de ca a la toma de entrada de cc de la videocámara.

Abra la cubierta de la toma y conecte la clavija de cc del adaptador de alimentación de ca. Asegúrese de que la marca ▲ de la clavija de cc está orientada hacia la marca ▲ de la videocámara.

4 Conecte el cable de alimentación al adaptador de alimentación de ca y al tomacorriente de pared.

El indicador CHG (carga) se enciende y se inicia el proceso de carga. El indicador CHG (carga) se apaga cuando la batería está completamente cargada.

5 Una vez cargada la batería, desconecte el adaptador de alimentación de ca de la toma de entrada de cc de la videocámara.

Notas

- Desconecte el adaptador de alimentación de ca de la toma de entrada de cc sujetando a la vez la videocámara y la clavija de cc

Para extraer la batería

- 1 Deslice el interruptor POWER hacia la posición OFF (CHG).
- 2 Extraiga la batería en el sentido de la flecha mientras mantiene presionado el botón BATT (liberación de la batería).

Botón BATT (liberación de la batería)

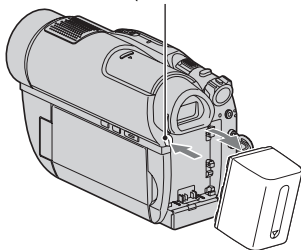

Notas

- Cuando extraiga la batería o desconecte el adaptador de alimentación de ca compruebe que el indicador (Película)/ (Imagen fija) o el indicador ACCESS o de acceso estén apagados.
- Cuando se disponga a guardar la batería durante un período prolongado, descárguela completamente antes de guardarla.

Para utilizar una fuente de alimentación conectada a un tomacorriente de pared

Realice las mismas conexiones que las indicadas para cargar la batería. La batería no se descargará en ese caso.

Para comprobar la energía restante de la batería (Battery Info)

Ajuste el interruptor POWER en la posición OFF (CHG) y, a continuación, presione DISP/BATT INFO.

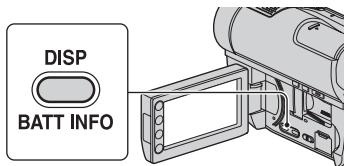

Tras unos instantes, aparecerán el tiempo de grabación y la información sobre la energía durante unos 7 segundos. Puede ver la información sobre la batería durante un máximo de 20 segundos si presiona de nuevo DISP/BATT INFO mientras aparece dicha información.

Energía restante de la batería (aprox.)

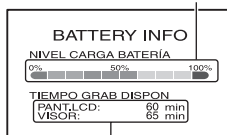

Capacidad de grabación (aprox.)

Tiempo de carga

Tiempo aproximado (min) necesario para cargar completamente una batería totalmente descargada.

Batería	Tiempo de carga
NP-FH50	135
NP-FH60 (suministrado)	135
NP-FH70	170
NP-FH100	390

Paso 2: Carga de la batería (Continúa)

Tiempo de grabación disponible

Tiempo aproximado (min) disponible cuando utiliza una batería completamente cargada.

“HD” significa calidad de imagen de alta definición, mientras que “SD” significa calidad de imagen estándar.

Si ajusta el soporte en la memoria interna (HDR-UX20) o el “Memory Stick PRO Duo”:

Batería	Tiempo de grabación continua		Tiempo de grabación normal*	
	HD	SD	HD	SD
Calidad de imagen				
NP-FH50	70	90	35	45
	75	95	40	50
NP-FH60 (suministrado)	95	120	50	60
	100	130	50	65
NP-FH70	150	195	80	100
	160	205	85	105
NP-FH100	350	440	180	230
	370	470	190	245

Si ajusta el soporte en el disco:

Batería	Tiempo de grabación continua		Tiempo de grabación normal*	
	HD	SD	HD	SD
Calidad de imagen				
NP-FH50	60	80	30	40
	65	85	35	45
NP-FH60 (suministrado)	80	105	40	55
	90	115	45	60
NP-FH70	130	170	65	90
	140	185	70	95
NP-FH100	305	385	160	200
	325	415	170	215

* El tiempo de grabación normal indica el tiempo de grabación al repetir las operaciones de inicio/parada, conexión/desconexión de la alimentación y utilización del zoom.

📌 Notas

- Tiempos obtenidos con la opción [MODO GRAB.] ajustada en [HD SP]/[SD SP] y en las condiciones siguientes:
Mitad superior: con la luz de fondo de la pantalla LCD encendida.
Mitad inferior: grabación con el visor y con el panel LCD cerrado.

Tiempo de reproducción disponible

Tiempo aproximado (min) disponible cuando utiliza una batería completamente cargada.

“HD” significa calidad de imagen de alta definición, mientras que “SD” significa calidad de imagen estándar.

Si ajusta el soporte en la memoria interna (HDR-UX20) o el “Memory Stick PRO Duo”:



Batería	Panel LCD abierto*		Panel LCD cerrado	
	HD	SD	HD	SD
Calidad de imagen				
NP-FH50	110	125	120	135
NP-FH60 (suministrado)	145	165	160	180
NP-FH70	235	270	255	290
NP-FH100	535	600	580	650

Si ajusta el soporte en el disco:

Batería	Panel LCD abierto*		Panel LCD cerrado	
	HD	SD	HD	SD
Calidad de imagen				
NP-FH50	90	100	100	115
NP-FH60 (suministrado)	120	135	130	150
NP-FH70	195	220	215	245
NP-FH100	440	500	485	555

* Con la luz de fondo de la pantalla LCD encendida.

Acerca de la batería

- Antes de cambiar la batería, deslice el interruptor POWER hacia la posición OFF (CHG) y apague los indicadores  (Película)/  (Imagen fija) o los indicadores ACCESS o de acceso.
- El indicador  /CHG (flash/carga) parpadeará durante la carga o bien la Battery Info no se mostrará correctamente en las siguientes situaciones:
 - La batería no está conectada correctamente.
 - La batería está dañada.
 - La batería está completamente gastada (sólo para Battery Info).
- Cuando el adaptador de alimentación de ca esté conectado a la toma de entrada de cc de la videocámara, la batería no suministrará alimentación aunque el cable de alimentación esté desconectado del tomacorriente de pared.
- Si se conecta una luz de video opcional, se recomienda utilizar una batería NP-FH70 o NP-FH100.
- No se recomienda el uso de la batería NP-FH30, ya que sólo permite tiempos de grabación y reproducción breves con la videocámara.

Acerca del tiempo de carga/grabación/reproducción

- Tiempos obtenidos al utilizar la videocámara a una temperatura de 25 °C (se recomienda una temperatura de 10 °C a 30 °C)
- El tiempo de grabación y de reproducción serán más cortos cuando utilice la videocámara a bajas temperaturas.
- En función de las condiciones en las que utilice la videocámara, es posible que el tiempo de grabación y reproducción se vean reducidos.

Acerca del adaptador de alimentación de ca

- Si utiliza el adaptador de alimentación de ca conéctelo a un tomacorriente de pared cercano. Si se produce alguna falla de funcionamiento al utilizar la videocámara, desconecte el adaptador de alimentación de ca del tomacorriente de inmediato.
- No utilice el adaptador de alimentación de ca colocado en un espacio angosto, tal como entre una pared y los muebles.

- No provoque un cortocircuito en la clavija de cc del adaptador de alimentación de ca ni en el terminal de la batería con algún objeto metálico, ya que podrían producirse fallas de funcionamiento.
- Aunque la videocámara esté apagada, seguirá recibiendo adaptador de alimentación de ca (corriente doméstica) mientras esté conectada a la toma de pared mediante el adaptador de alimentación de ca

Paso 3: Encendido de la videocámara y ajuste de la fecha y la hora

Ajuste la fecha y la hora cuando utilice la videocámara por primera vez. Si no ajusta la fecha y la hora, aparecerá la pantalla [AJUS.RELOJ] cada vez que encienda la videocámara o cambie la posición del interruptor POWER.

Toque el botón de la pantalla LCD.

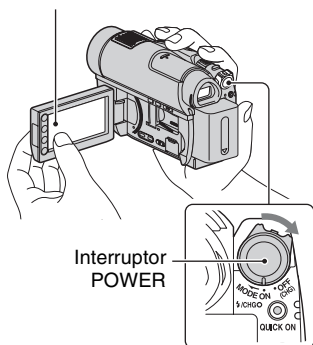



1 Mientras mantiene presionado el botón verde, deslice el interruptor POWER varias veces en el sentido de la flecha hasta que se encienda el indicador correspondiente.

 (Película): para grabar películas



 (Imagen fija): para grabar imágenes fijas

La primera vez que encienda la videocámara, vaya directamente al paso **3**.



2 Toque  (HOME) →  (AJUSTES) → [AJ.REL./IDIOM. ] → [AJUS.RELOJ].

Aparece la pantalla [AJUS.RELOJ].







3 Seleccione la zona geográfica deseada mediante  /  y, a continuación, toque [SIGUIENTE].

4 Ajuste [HORA VERANO] y, a continuación, toque [SIGUIENTE].

5 Ajuste [A] (año) con  / .



6 Seleccione [M] con  /  y, a continuación, ajuste el mes con  / .

7 Ajuste [D] (día), la hora y los minutos del mismo modo y, a continuación, toque [SIGUIENTE].

8 Compruebe que el reloj se haya ajustado correctamente y, a continuación, toque .





El reloj empezará a funcionar.

Puede seleccionar cualquier año hasta el 2037.

Para las doce de la noche, ajústelo en las 12:00 AM.

Para las doce del mediodía, ajústelo en las 12:00 PM.

Cambio del ajuste de idioma

Puede modificar las indicaciones en pantalla para que muestren los mensajes en un idioma determinado. Para seleccionar el idioma en pantalla, toque  (HOME) →  (AJUSTES) → [AJ.REL./IDIOM. ] → [AJUSTE IDIOMA .

Para apagar la videocámara

Deslice el interruptor POWER hacia la posición OFF (CHG).

Notas

- Si no utiliza la videocámara durante **3 meses aproximadamente**, la batería recargable incorporada se descargará y es posible que los ajustes de fecha y hora se borren de la memoria. En este caso, cargue la batería recargable incorporada y ajuste la fecha y la hora de nuevo.
- La videocámara demorará unos segundo en estar lista para grabar al encenderla. Durante este período no podrá utilizar la videocámara.
- La cubierta del objetivo se abre en forma automática al encender la videocámara. Se cierra al seleccionar la pantalla de reproducción o al apagar la videocámara.
- Con el fin de ahorrar energía de la batería, cuando se adquiere la videocámara, ésta viene ajustada para apagarse automáticamente si se deja encendida sin realizar ninguna operación durante unos 5 minuto ([APAGADO AUTO]).

Sugerencias

- La fecha y la hora no aparecen durante la grabación, aunque se graban automáticamente en el soporte y se pueden mostrar durante la reproducción ([CÓDIGO DATOS]).
- Si los botones del panel táctil no funcionan correctamente, ajuste el panel táctil (CALIBRACIÓN).

Paso 4: Realización de ajustes previos a la grabación

Ajuste del panel LCD

Abra el panel LCD 90 grado respecto a la videocámara (①) y, a continuación, gírelo en el ángulo que le resulte más adecuado para grabar o reproducir (②).

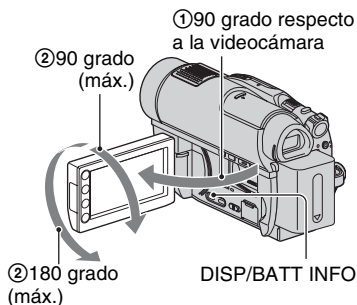

Para desactivar la luz de fondo de la pantalla LCD y conseguir que la batería dure más tiempo

Mantenga presionado DISP/BATT INFO durante unos segundos hasta que aparezca .



Este ajuste resulta práctico cuando utiliza la videocámara en condiciones de mucho brillo o si desea ahorrar energía de la batería. Este ajuste no afectará a la imagen grabada. Para encender la luz de fondo de la pantalla LCD, mantenga presionado DISP/BATT INFO durante unos segundos hasta que  desaparezca.

Notas

- No presione accidentalmente los botones del marco de la pantalla LCD cuando abra o ajuste el panel.

Sugerencias

- Si abre el panel LCD 90 grados hacia la videocámara y, a continuación, lo gira 180 grados hacia el lado del objetivo, podrá cerrar el panel LCD con la pantalla hacia afuera. Este procedimiento resulta conveniente para las operaciones de reproducción.

- Toque  (HOME) →  (AJUSTES) → [AJUS.SON./PANT.] → [BRILLO LCD] para ajustar el brillo de la pantalla LCD.
- La información se mostrará u ocultará (visualización ↔ no visualización) cada vez que presione DISP/BATT INFO.



Ajuste del visor

Podrá contemplar las imágenes a través del visor y con el panel LCD cerrado para evitar que la batería se desgaste, o siempre que la calidad de la imagen de la pantalla LCD sea muy baja.

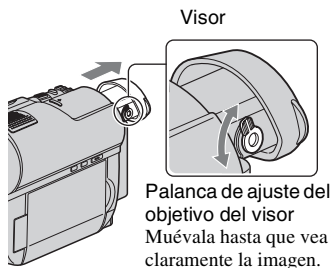
Tire del visor para extraerlo y, a continuación, coloque los ojos en él para observar las imágenes. Ajuste el visor para obtener una imagen nítida que se ajuste a su vista.



Sugerencias

- Para ajustar el brillo de la luz de fondo del visor, toque  (HOME) →  (AJUSTES) → [AJUS.SON./PANT.] → [LUZ F.VISOR].

Ajuste de la correa de sujeción

Apriete la correa de sujeción y sujete la videocámara correctamente.

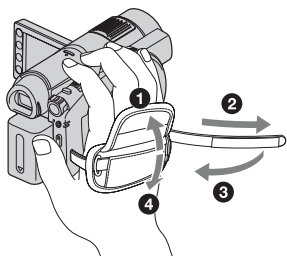

Paso 5: Selección del soporte

Es posible seleccionar el soporte deseado para la grabación, reproducción o edición de películas o imágenes fijas en función de sus necesidades.

En el caso del soporte para películas, deberá ajustar la memoria interna*/disco**/“Memory Stick PRO Duo” y, además, la calidad de imagen ([HDI] (alta definición) o [SD] (definición estándar)). En el caso del soporte para imágenes fijas, ajuste únicamente la memoria interna*/“Memory Stick PRO Duo”. A continuación se indican los ajustes predeterminados.

HDR-UX10:

Película: disco

Imagen fija: “Memory Stick PRO Duo”**

HDR-UX20:

Película: memoria interna

Imagen fija: memoria interna

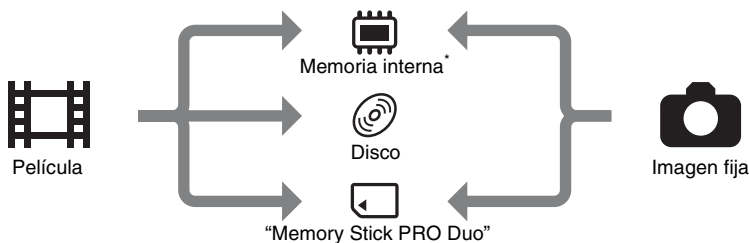

* HDR-UX20

** En el modelo HDR-UX10, el soporte para imágenes fijas queda fijado en el “Memory Stick PRO Duo”.

Selección del soporte para películas

- 1 Toque (HOME) → (GESTIONAR SOPORTE) → [AJ.SOPORTE PEL.].

Aparecerá la pantalla de selección del soporte para películas.

- 2 Toque la calidad de imagen y el soporte deseados.



- ① [HDI] MEMORIA INT.] (HDR-UX20)
Soporte: memoria interna
Calidad de imagen: HD (alta definición)
- ② [HDI] MEMORY STICK]
Soporte: “Memory Stick PRO Duo”
Calidad de imagen: HD (alta definición)
- ③ [DISCO]
Soporte: disco
Calidad de imagen: HD (alta definición) o SD (definición estándar)
La calidad de imagen se selecciona en el “Paso 6”.
- ④ [HSD] MEMORIA INT.] (HDR-UX20)
Soporte: memoria interna
Calidad de imagen: SD (definición estándar)
- ⑤ [HSD] MEMORY STICK]
Soporte: “Memory Stick PRO Duo”
Calidad de imagen: SD (definición estándar)

- 3 Toque [SÍ].

4 Cuando aparezca [Finalizado.], toque **[OK]**.

El soporte para películas quedará ajustado.

Selección del soporte para imágenes fijas (HDR-UX20)

1 Toque **HOME** → **(GESTIONAR SOPORTE)** → **[AJ.SOPORTE FOTO]**.

Aparecerá la pantalla de selección del soporte para imágenes fijas.



2 Toque el soporte deseado.

Notas

- No es posible seleccionar el disco como soporte para imágenes fijas.

3 Toque **[SÍ]**.

4 Cuando aparezca [Finalizado.], toque **[OK]**.

El soporte para imágenes fijas quedará ajustado.

Para confirmar el ajuste del soporte

- ① Deslice el interruptor POWER varias veces hasta que se ilumine el indicador correspondiente (**[Película]** / **[Imagen fija]**).
- ② El icono del soporte aparece en la esquina superior derecha de la pantalla.



	Memoria interna (HDR-UX20)
	Disco El icono que aparece en la pantalla varía en función del disco empleado.
	“Memory Stick PRO Duo”

Sugerencias

- Para grabar, reproducir o editar en otros soportes, cambie el ajuste del soporte.

Paso 6: Inserción de un disco o un “Memory Stick PRO Duo”

Si ajusta el soporte en la memoria interna (HDR-UX20) para grabar imágenes en el “Paso 5”, no será necesario ejecutar el procedimiento del “Paso 6”.

Disco

Si ajusta el soporte en [DISCO] en el “Paso 5”, se necesitará un DVD-RW, DVD+RW, DVD-R o DVD+R DL nuevo de 8 cm para la grabación.

Notas

- Con la ayuda de un paño suave, elimine primero el polvo o las huellas dactilares del disco.

1 Compruebe que la videocámara está encendida.

2 Deslice el interruptor OPEN de la cubierta del disco en el sentido de la flecha (OPEN →).

Aparecerá [ABRIENDO...] en la pantalla LCD y, a continuación, la cubierta del disco se abrirá ligeramente en forma automática.

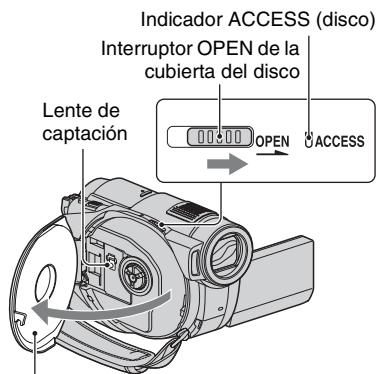

Cuando la cubierta del disco se abra ligeramente, ábrala del todo.

3 Coloque el disco con la cara de grabación dirigida hacia la videocámara y, a continuación, presione la parte central del disco hasta que haga clic.

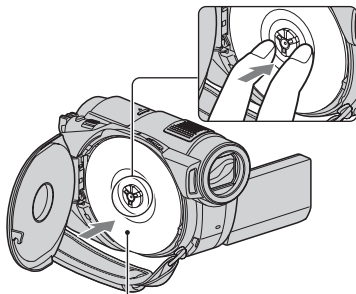

Si utiliza un disco de una sola cara, colóquelo con la cara de la etiqueta mirando hacia fuera.

4 Cierre la cubierta del disco.

[ACCESO A DISCO] aparece en la pantalla LCD.

En función del tipo de disco y de su estado, es posible que la videocámara demore un tiempo en detectarlo. Si utiliza un DVD-R/DVD+R DL, vaya directamente al paso 7.

5 Si utiliza un DVD-RW/DVD+RW, toque [Utilizar la GUÍA SELECT.DISCO].

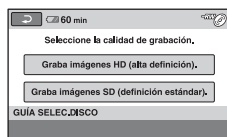

Notas

- No es posible utilizar la función [Utilizar la GUÍA SELECT.DISCO.] durante el modo de operación Easy Handycam. Siga las instrucciones que aparecen en la pantalla para formatear el disco.

6 Toque [Graba imágenes HD (alta definición)].

Toque [Graba imágenes SD (definición estándar).] para grabar con calidad de imagen SD (definición estándar). Los elementos que aparezcan dependerán del estado de la videocámara o del tipo de disco insertado.

7 Toque la opción apropiada en la pantalla.

El disco se formateará con la calidad de grabación de imágenes que haya seleccionado. Una vez finalizado el formateo, ya puede iniciar la grabación en el disco.

Si selecciona la calidad de imagen SD (definición estándar)

- Si utiliza un DVD-RW, seleccione el formato de grabación, [VIDEO] o [VR]. Si formatea un disco durante el modo de operación Easy Handycam, el formato de grabación quedará fijado en [VIDEO].
- Si utiliza un DVD+RW, seleccione el formato: [PANORÁM.16:9] o [4:3].

Para extraer el disco

- Realice los pasos 1 y 2 para abrir la cubierta del disco.
- Levante un extremo del disco mientras mantiene apretada la pieza de sujeción del disco de la parte central.

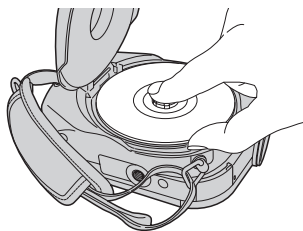

Notas

- No es posible cambiar la calidad de imagen (HD (alta definición) o SD (definición estándar)) de un disco en pleno proceso.
- Procure no obstruir la operación con la mano u otros objetos al abrir o cerrar la cubierta del disco. Desplace la correa hasta la parte inferior de la videocámara y, a continuación, abra o cierre la cubierta del disco.
- Si la correa queda atrapada al cerrar la cubierta del disco, podría provocar una falla de funcionamiento de la videocámara.
- No toque la cara de grabación del disco ni la lente de captación. Si utiliza un disco de doble cara, procure no manchar la superficie con los dedos.
- Si cierra la cubierta del disco con el disco mal colocado, podría provocar una falla de funcionamiento de la videocámara.
- No desconecte las fuentes de alimentación durante el formateo.
- No someta la videocámara a golpes ni vibraciones en las siguientes situaciones:
 - cuando el indicador ACCESS esté encendido
 - cuando el indicador ACCESS parpadee
 - cuando aparezca [ACCESO A DISCO] o [ABRIENDO...] en la pantalla
- En función del estado del disco o del material grabado, es posible que demore un poco en extraer el disco.
- Podría demorar hasta 10 minutos para extraer el disco si éste está dañado o sucio con huellas dactilares, etc. En tal caso, es posible que el disco esté dañado.

Sugerencias

- Podrá extraer el disco con una fuente de alimentación conectada a la videocámara aunque ésta última se encuentre apagada. Sin embargo, el proceso de detección del disco (paso 4) no se iniciará.

Paso 6: Inserción de un disco o un "Memory Stick PRO Duo" (Continúa)

- Para asegurarse de que utiliza el disco adecuado, consulte la [GUÍA SELEC.DISCO] del HOME MENU.

"Memory Stick PRO Duo"

Si ajusta el soporte en "Memory Stick" en el "Paso 5", se necesitará un "Memory Stick PRO Duo" para la grabación.

Sugerencias

- Para grabar únicamente imágenes fijas en el "Memory Stick PRO Duo", no es necesario realizar el procedimiento a partir del paso 3.

1 Abra el panel LCD.

2 Inserte el "Memory Stick PRO Duo".

- 1 Abra la cubierta del Memory Stick Duo en el sentido de la flecha.
- 2 Inserte el "Memory Stick PRO Duo" en la ranura para Memory Stick Duo en la dirección correcta hasta que quede encajado.
- 3 Cierre la cubierta del Memory Stick Duo.

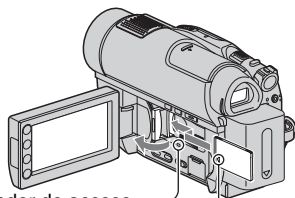

Indicador de acceso

La marca ◀ debe quedar mirando a la pantalla LCD de la videocámara.

3 Cuando el soporte para películas esté ajustado en [FHD] MEMORY STICK] o [HSD] MEMORY STICK] en el "Paso 5", deslice el interruptor POWER para que se ilumine el indicador (Película).

Si el interruptor POWER está ajustado en OFF (CHG), enciéndalo mientras mantiene presionado el botón verde.

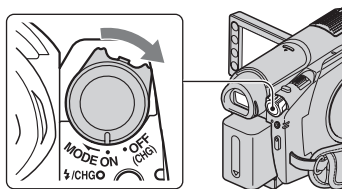

Cuando inserte un "Memory Stick PRO Duo" nuevo, aparecerá la pantalla [Crear nuevo arch.base de datos de imágenes.] en la pantalla LCD.

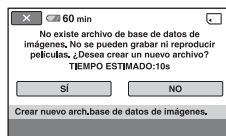

4 Toque [SÍ].

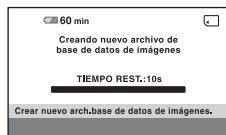

Expulsar un “Memory Stick PRO Duo”

Abra el panel LCD y la cubierta del Memory Stick Duo y, a continuación, empuje ligeramente hacia adentro el “Memory Stick PRO Duo” y deslícelo hacia afuera por el cuerpo de la videocámara.

Notas

- Para evitar que el soporte se rompa o se pierdan las imágenes grabadas, no realice las siguientes acciones mientras el indicador de acceso esté iluminado o parpadee:
 - Retirar la batería o el adaptador de alimentación de ca
 - Someter la videocámara a sacudidas o golpes
 - Expulsar un “Memory Stick PRO Duo”
- No abra la cubierta del Memory Stick Duo durante la grabación.
- Si fuerza el “Memory Stick PRO Duo” en la ranura en la dirección incorrecta, es posible que el “Memory Stick PRO Duo”, la ranura para Memory Stick Duo o los datos de imágenes queden dañados.
- Si aparece [Error al crear un nuevo archivo de base de datos de imágenes. Es posible que no exista suficiente espacio libre.] en el paso 4, formatee el “Memory Stick PRO Duo”. Tenga en cuenta que al formatear se borrarán todos los datos grabados en el “Memory Stick PRO Duo”.
- No presione ni expulse el “Memory Stick PRO Duo” a la fuerza, ya que podrían producirse fallas de funcionamiento.

Capacidad de un “Memory Stick PRO Duo” y tiempo disponible de grabación de películas

Tiempo de grabación aproximado en minuto.

Las cifras () corresponden al tiempo mínimo de grabación.

Calidad de imagen HD (alta definición):

	AVC HD 16M (FH)	AVC HD 9M (HQ)	AVC HD 7M (SP)	AVC HD 5M (LP)
1 GB	6 (6)	10 (9)	15 (10)	20 (15)
2 GB	10 (10)	25 (20)	30 (20)	40 (35)
4 GB	25 (25)	55 (40)	65 (45)	85 (70)
8 GB	55 (55)	115 (80)	140 (100)	180 (145)

Calidad de imagen SD (definición estándar):

	SD 9M (HQ)	SD 6M (SP)	SD 3M (LP)
1 GB	10 (10)	20 (10)	35 (25)
2 GB	25 (25)	40 (25)	80 (50)
4 GB	55 (50)	80 (50)	160 (105)
8 GB	115 (100)	170 (100)	325 (215)

Notas

- Las cifras de la tabla corresponden al uso de un “Memory Stick PRO Duo” fabricado por Sony Corporation. El tiempo de grabación disponible varía en función de las condiciones de grabación, el tipo de “Memory Stick” o el ajuste de [MODO GRAB.].

Grabación

Las imágenes se graban en el soporte ajustado. A continuación se indican los ajustes predeterminados.

HDR-UX10:

Película: disco

Imagen fija: "Memory Stick PRO Duo"

HDR-UX20:

Película: memoria interna

Imagen fija: memoria interna

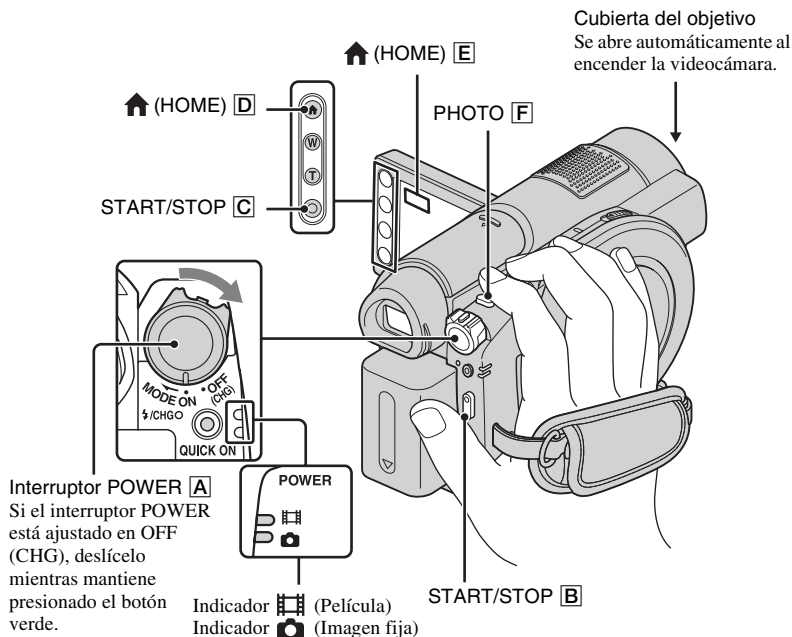

Notas

- Si el indicador ACCESS o el indicador de acceso se ilumina o parpadea una vez finalizada la grabación, significa que todavía se están escribiendo datos en el soporte. Durante ese tiempo, no someta la videocámara a golpes ni vibraciones ni retire la batería o el adaptador de alimentación de ca. Tampoco expulse el "Memory Stick PRO Duo" de la videocámara.
- Cuando un archivo de película supera los 2 GB con el soporte ajustado en la memoria interna (HDR-UX20) o el "Memory Stick", se creará automáticamente un nuevo archivo de película.

Sugerencias

- Para consultar el tiempo de grabación disponible y el uso de memoria del soporte, toque **HOME (D)** (o **E**) → **(GESTIONAR SOPORTE)** → **[INFO SOPORTE]**.

Grabación de películas



- 1 Deslice el interruptor POWER **A** en el sentido de la flecha para que se ilumine el indicador (Película).

- 2 Presione START/STOP **B** (o **C**).

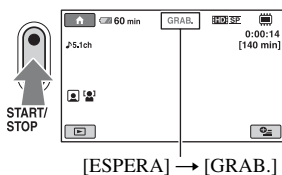

Para detener la grabación, presione START/STOP nuevamente.

Grabación de imágenes fijas



- 1 Deslice el interruptor POWER **A** en el sentido de la flecha para que se ilumine el indicador (Imagen fija).

- 2 Presione PHOTO **F** ligeramente para ajustar el enfoque **A** (sonará un pitido) y, a continuación, presiónelo a fondo **B** (se escuchará el sonido del obturador).

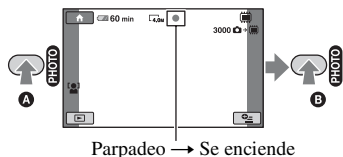

Aparecerá la marca roja junto a o . Cuando la marca roja desaparece, significa que se grabó la imagen.

Notas

- No es posible grabar imágenes fijas en un disco.

Sugerencias

- Si presiona PHOTO **F** (Dual Rec) durante la grabación de películas, podrá grabar imágenes fijas.
- Se mostrará un marco en las caras detectadas, con lo que la imagen de la cara se optimizará en forma automática ([DETECCIÓN CARA]).
- Cuando se detecte una cara durante la grabación de películas, parpadeará y la cara se grabará en el índice de caras. Cuando reproduzca una película, podrá buscar las escenas deseadas por las caras (índice de caras).
- Es posible capturar imágenes fijas a partir de una película grabada.
- Para cambiar el modo de grabación, toque (HOME) **D** (o **E**) → (TOMA DE IMÁGENES) → [PELÍCULA] o [FOTO].

Reproducción

Reproduzca las imágenes grabadas en el soporte seleccionado. A continuación se indican los ajustes predeterminados.

HDR-UX10:

Película: disco

Imagen fija: "Memory Stick PRO Duo"

HDR-UX20:

Película: memoria interna

Imagen fija: memoria interna

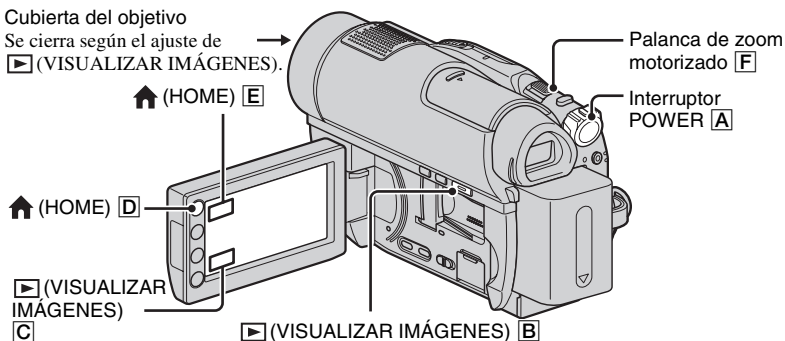

1 Deslice el interruptor POWER **[A]** para encender la videocámara.

2 Presione **[VISUALIZAR IMÁGENES]** **[B]** (o **[C]**).

Aparecerá la pantalla VISUAL INDEX en la pantalla LCD (es posible que demore un tiempo en visualizar las miniaturas).

Aparece en la imagen de cada ficha que se reprodujo o grabó por última vez
(▶ en el caso de imágenes fijas grabadas en un "Memory Stick PRO Duo").

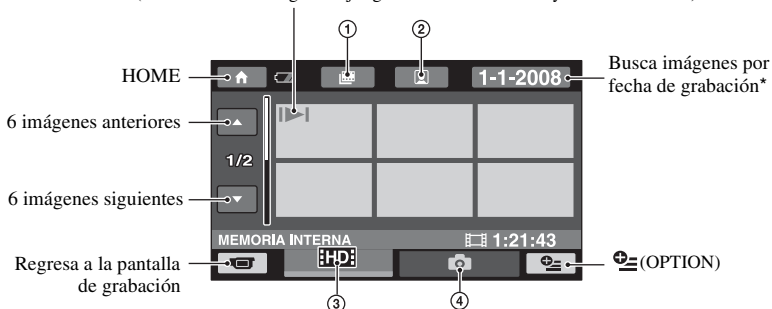

- ① : va a la pantalla de índice de películas.
- ② : va a la pantalla de índice de caras.
- ③ : muestra las películas con calidad de imagen HD (alta definición).
Al seleccionar la calidad de imagen SD (definición estándar) en [AJ.SOPORTE PEL.], aparece . Al seleccionar [DISCO], aparece .
- ④ : muestra las imágenes fijas.

*No es posible buscar la película deseada por la fecha de grabación si ajusta [DISCO] en [AJ.SOPORTE PEL.].

Sugerencias

- Es posible cambiar el número de imágenes de la pantalla VISUAL INDEX de 6 ↔ 12 moviendo la palanca del zoom motorizado [F]. Para fijar este número, toque (HOME) [D] (o [E]) → (AJUSTES) → [VIS.AJUSTES IMÁG] → [PANTALLA].

3 Inicie la reproducción.

Reproducción de películas

Toque la ficha , o y la película que desea reproducir.

Cuando la reproducción a partir de la película seleccionada alcanza la última película, la visualización regresa a la pantalla VISUAL INDEX.

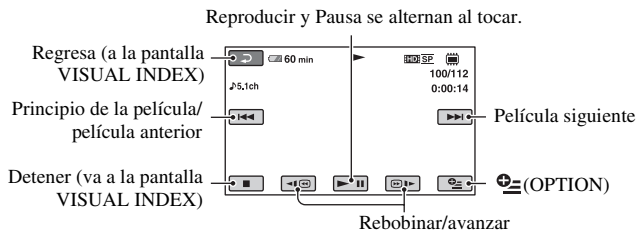

Sugerencias



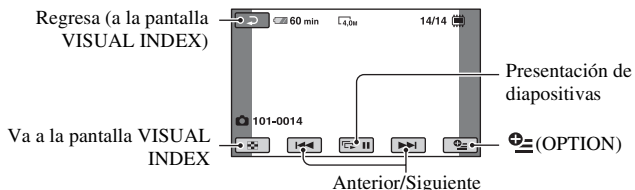

- Toque / durante la pausa para reproducir la película a cámara lenta.
- Cuando reproduzca una película en la memoria interna (HDR-UX20) o el “Memory Stick PRO Duo”, al tocar / una vez aumentará unas 5 veces la velocidad de rebobinado o avance rápido, con 2 presiones aumentará unas 10 veces, con 3 presiones aumentará unas 30 veces y con 4 presiones aumentará unas 60 veces.
- Cuando reproduzca una película en el disco, al tocar / una vez aumentará la velocidad de rebobinado o avance rápido unas 5 veces y con 2 presiones aumentará unas 10 veces (unas 8 veces si utiliza un DVD+RW con calidad de imagen SD (definición estándar)).

Visualización de imágenes fijas



Toque la ficha  y la imagen fija que desea reproducir.



Para ajustar el volumen del sonido de las películas

Al reproducir una película, toque  (OPTION) → ficha  → [VOL.] y, a continuación, ajuste el volumen con  / .

Sugerencias

- Es posible alternar la pantalla VISUAL INDEX si toca  (HOME)  (o ) →  (VISUALIZAR IMÁGENES) → [VISUAL INDEX].

Additional information on this product and answers to frequently asked questions can be found at our Customer Support Website.

<http://www.sony.net/>



Printed on 70% or more recycled paper using VOC (Volatile Organic Compound)-free vegetable oil based ink.

Printed in Japan



3285372110